

## User manual and technical description



**PURA**

**Multifunctional chair**



D9U001ODA-0101  
Version: 03  
Publication Date: 2024-03

## **Manufacturer:**

L I N E T spol. s r.o.  
Želevčice 5  
274 01 Slaný  
Česká republika

Tel.: +420 312 576 111  
Fax: +420 312 522 668

E-mail: [info@linet.cz](mailto:info@linet.cz)  
<http://www.linet.com>  
Service department: [service@linetgroup.com](mailto:service@linetgroup.com)

## **Authorized Representative in Great Britain:**

LINET UK Ltd  
11 Brunel Way  
Segensworth East  
Fareham  
Hampshire  
PO15 5TX  
United Kingdom

## **Authorized Representative in Switzerland:**

Bigla Care AG  
Bernstrasse 3  
CH-3421 Lyssach  
Switzerland

## **Authorized Representative in Malaysia:**

INTERSCIENCE SDN. BHD  
2, Jalan Sg. Kayu Ara 32/38,  
Berjaya Industrial Park  
40460 Shah Alam,  
Selangor Darul Ehsan  
Malaysia

## **Authorized Representative in Peru:**

Drogería Emergo Peru S.R.L.  
Calle Las Orquídeas Nro. 585, Int. 1301  
San Isidro, Lima  
Director Técnico Renato Delgado Rivera  
RUC: 205 52 75 65 35  
Peru

## **Authorized Representative in Philippines:**

Biomedica Healthcare Inc.  
Unit 2103 City land 10, Tower 1  
Ayala Corner, Dela Costa Street  
Makati City, Metro Manila  
Philippines

## LINET

### **PURA**

Multifunctional chair

Author: L I N E T spol. s r.o.  
Related links: [www.linnet.com](http://www.linnet.com)

### **D9U001ODA-0101**

Version: 03  
Publication Date: 2024-03

Copyright © L I N E T spol. s r.o., 2024  
Translation © L I N E T spol. s r.o., 2024  
All rights reserved

All trademarks and brands are the property of the appropriate owners. The manufacturer reserves the right to changes in the contents of this manual that relate to the product's technical regulations. It is for this reason that the contents of this manual may indicate differences from the current manufacture of the product.

## Table of Contents

<b>1 INTRODUCTION</b> .....	<b>6</b>
<b>2 SAFETY AND DANGERS</b> .....	<b>14</b>
2.1 Safety instructions .....	14
<b>3 UN-PACKING MANUAL</b> .....	<b>17</b>
<b>4 OVERVIEW OF BASIC PARTS</b> .....	<b>21</b>
4.1 Overview of basic versions .....	21
4.2 Safety .....	22
<b>5 FUNCTION</b> .....	<b>23</b>
5.1 Interaction.....	23
5.2 General instructions .....	23
5.3 Application environment 5.....	23
<b>6 INTENDED USE</b> .....	<b>24</b>
6.1 User population .....	24
6.2 Contraindications .....	24
6.3 Operator .....	24
<b>7 ELECTRICAL SAFETY</b> .....	<b>25</b>
7.1 Electromagnetic compatibility.....	27
7.2 Mechanical safety .....	29
<b>8 SETTING THE PRODUCT</b> .....	<b>29</b>
8.1 Transport, braking .....	30
8.2 Transportation of the chair from one place to another .....	32
<b>9 OPERATING THE CHAIR</b> .....	<b>33</b>
9.1 Motor setting.....	34
9.2 Armrests .....	37
9.2.1 Basic armrest.....	37
9.2.2 Improper adjustment of the armrests.....	38
9.3 Siderails.....	39
9.4 Electric setting of Trendelenburg .....	40
9.5 Equipotential bonding.....	41
9.6 Rear head bumper .....	41
<b>10 ACCESSORIES</b> .....	<b>42</b>
10.1 Rotary holder of the infusion stand .....	42
10.2 Firm holder of the infusion stand.....	42
10.3 Pillow (flat).....	43
10.4 Pillow (half-round) .....	43
10.5 Pillow (for lying on the side) .....	43
10.6 Pillow (between the back and seat parts) .....	44
10.7 Big plastic box for personal things .....	44
10.8 Small lockable box for personal things .....	45
10.9 DIN lath .....	45
10.10 Paper roll holder .....	46
10.11 PVC cloth of elbow-rests (a pair) .....	46
10.12 PVC cloth of the leg rest .....	47
10.13 Tablet holder (L/R) .....	48
10.14 Oxygen bottle holder .....	49
10.15 Urine bag holder.....	49
10.16 Front buffer.....	50
10.17 Infusion stand.....	50
10.18 Eating table (version with barriers) .....	51





10.19 Eating table (for elbow-rest version) .....	52
10.20 Front central brake (a pair).....	54
10.21 Fifth wheel .....	55
10.22 Electric leg rest.....	56
10.23 USB cell-phone recharger.....	57
10.24 Patient fixation band.....	58
10.25 Front / rear transport handles.....	59
10.26 Height-adjustable elbow-rests.....	60
10.27 Elbow-rests with cavities for elbows .....	61
10.28 Controller holder for chair with armrests .....	62
10.29 Drink holder for chair with armrests .....	63
10.30 Mechanic CPR .....	64
10.31 Patient card holder .....	65
10.32 Drinking vessel holder.....	65
10.33 Cell-phone pocket .....	66
10.34 Comfort mattress (130 mm) .....	67
10.35 Backup battery .....	73
<b>11 CARE.....</b>	<b>74</b>
11.1 Cleaning and disinfection .....	75
11.1.1 Cleaning the chair.....	76
11.1.2 Recommended disinfection (disinfectants for wiping) .....	77
<b>12 MAINTENANCE .....</b>	<b>77</b>
12.1 List of error, malfunction and generated messages.....	78
12.2 Technical parameters.....	79
12.3 Electrical parameters .....	81
12.4 Storage instruction and transport .....	82
12.5 Service and repairs .....	82
12.6 Applied parts .....	83
<b>13 DISPOSAL .....</b>	<b>83</b>
13.1 Environment protection .....	84
13.2 Disposal.....	84
13.2.1 Within Europe .....	84
13.2.2 Outside Europe.....	85
14 Warranty.....	85









## 1 Introduction









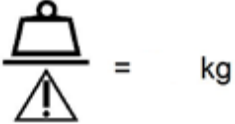

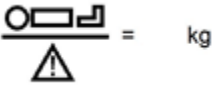
Please read carefully the whole instruction manual, which is designed to familiarize you with the correct use and the parameters of your new multifunctional chair. Please always follow the instructions contained in this manual and use the chair only in accordance with these instructions.

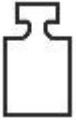
Please keep these instructions near the chair throughout its operation. Every person operating the chair PURA must read and understand the contents of these instructions.









Very important information is marked throughout the manual by the following symbols:







Logo	Meaning
	PRODUCT CERTIFICATION OF COMPLIANCE WITH EU RULES
	UK CONFORMITY ASSESSED (UKCA) MARKING (PRODUCT NORMATIVELY HARMONIZED FOR GREAT BRITAIN ECONOMIC AREA)
	AUTHORIZED REPRESENTATIVE IN GREAT BRITAIN
	AUTHORIZED REPRESENTATIVE IN SWITZERLAND

Pictogram	Meaning
	Danger
	Danger: Hazardous voltage
	This symbol refers to all information that may help you to avoid operational complications
	Applied parts B
	Applied parts BF
	Indoor use only
	Production number
	Type number meaning
INT x/y	Mark for intermittent functioning, this means that if the product is used without interruptions for an "x" period, then it should not be used for the "y" period. For example, int 10 / 20 means that after 10 minutes of use / continuous positioning the product should not be used / positioned for a period of 20 minutes.
IP X #	Structural protection against water infiltration, dangerous contact and resistance to extraneous objects
	Patient weight + load capacity of all accessories

Pictogram	Meaning
	Maximum patient weight
	Maximum product weight, including accessories in maximum configuration
	Maximum chair weight with SWL load
	Producer
	Date of production
	Follow the instructions manual
	Equipotentiality
	Earth ground
	Symbol of the packaging material: "Store in a dry place"
	Symbol of the packaging material: "Attention! Fragile"
	Symbol of the packaging material: "Hold in upright position"



Pictogram	Meaning
	Temperature limit
	Symbol for transport Symbol for "relative humidity of the air".
	Symbol for transport Symbol for "air pressure".
	Symbol according to the Directive 2002/96/EC (Directive on waste electrical and electronic equipment). Symbol for " Do not dispose of this product in the municipal collection points. Dispose of this product in the collection points for waste electrical and electronic equipment ".
	GO BUTTON
	STOP BUTTON
	<b>Warning:</b> Don't place items in this space
	<b>Warning:</b> Maximum load of the leg-support part
	<b>Warning:</b> Maximum load of the back part
	<b>Warning:</b> Don't place items onto this cover Risk of hand injuries
	<b>Warning:</b> Risk of hand injuries

Pictogram	Meaning
	<p><b>Caution:</b> Do not push / pull the infusion stand</p>
	<p>Cardiopulmonary resuscitation (CPR)</p>
	<p>MEDICAL DEVICE (compatible with Medical Device Regulation)</p>
	<p>UNIQUE DEVICE IDENTIFIER</p>
	<p>EAC MARKING</p>
	<p><b>Warning:</b> The power cable shall always be clamped on the selected place of the chair using a plastic hook as is recommended on picture!  Follow the instructions manual!</p>

## Placement of warning stickers - chair with armrests

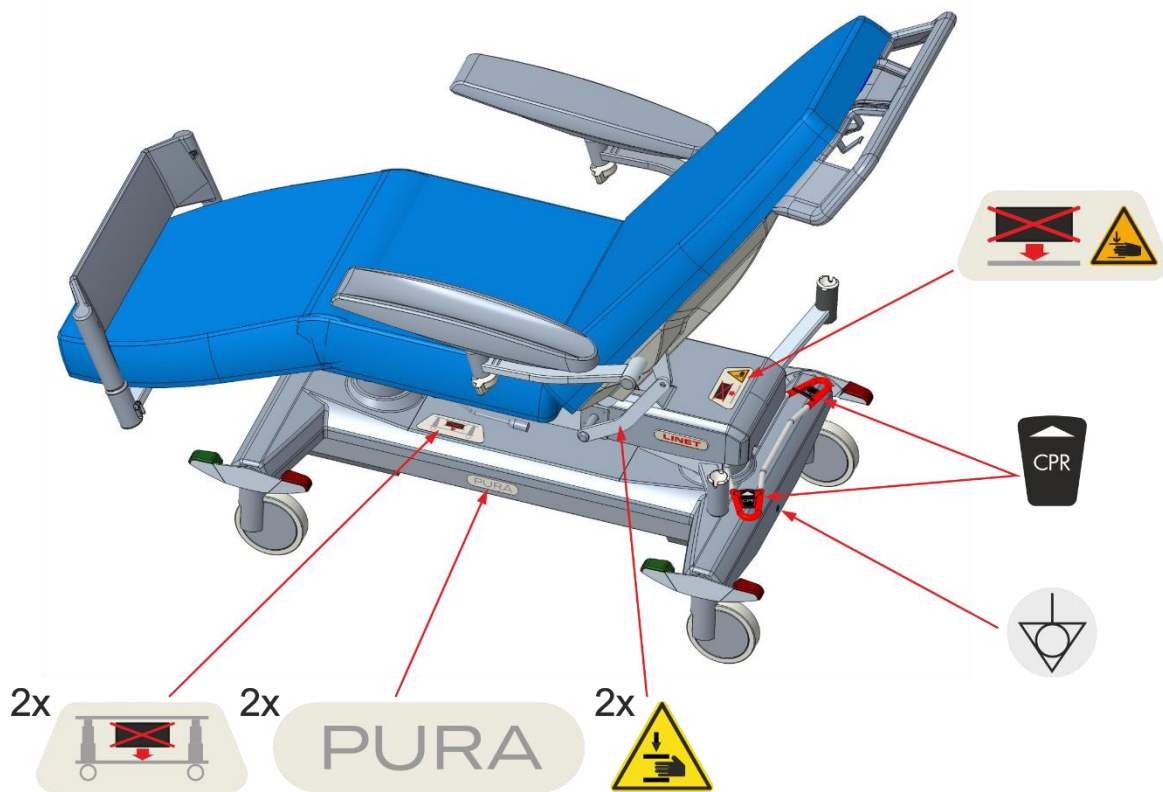

## Placement of warning stickers - chair with side guards

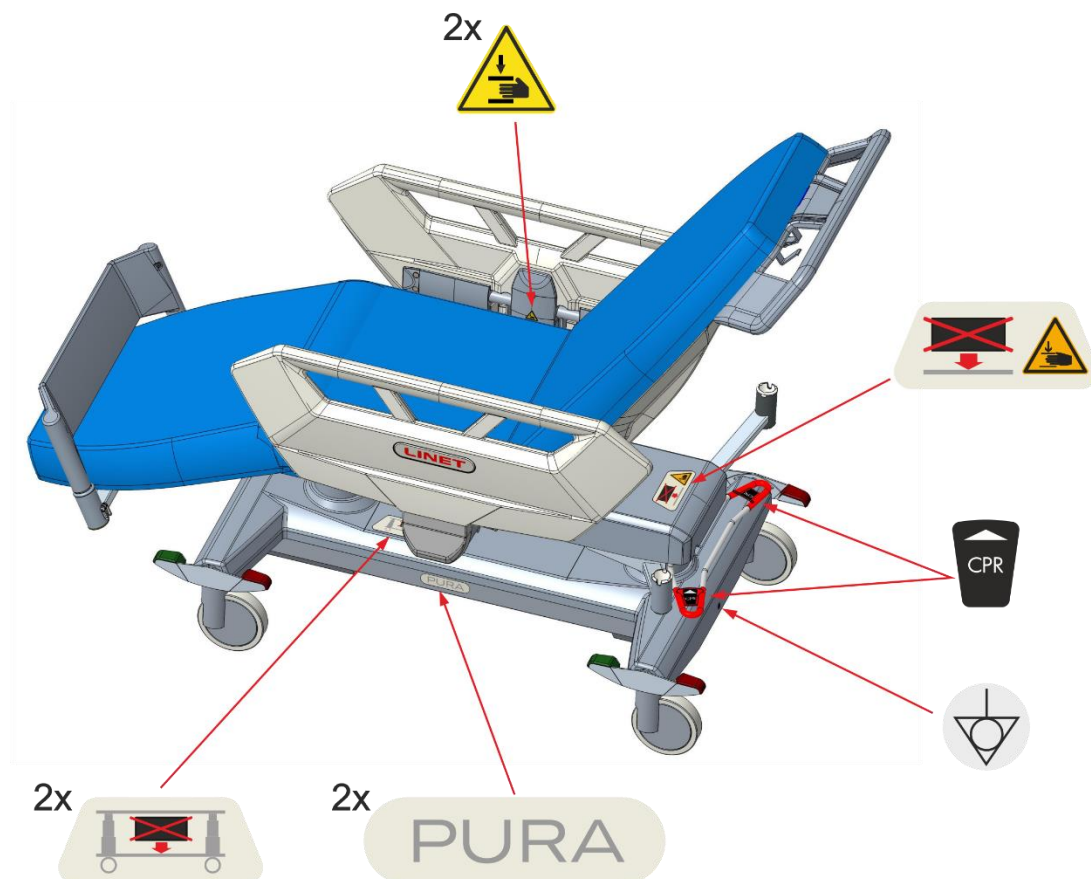

Abbreviation	Meaning
LED	Light emitting diodes
VA	Power intake unit
VGA	Computer standard for computer imaging technology
USB	Universal serial bus
LCD	Liquid crystal display
IT	Information technology
PC	Personal computer
dB	Sound intensity unit
hPa	Pressure unit
Hz	Frequency unit in the SI system
EMC	Electromagnetic compatibility
HF	High frequency
ME	Medical equipment
CISPR	International Special Committee on Radio Interference

Acoustic signalling	
Sound	Meaning
Sound signal 0.5 s, pause 2.5 s	Error in the STOP function safety circuit
Continuous signal	CB electronics overheated
Continuous signal	Battery overcurrent
Continuous signal	Motors overloaded
Short sound signal during positioning.	The chair zero position achieved

## Production label with UDI:

The serial label contains information about Address of Manufacturer, Manufacturing Date (Year-Month-Day), Product Reference Number, Product Serial Number, Global Trade Item Number (GTIN), Unique Device Identification (UDI), symbols, weight specifications and electrical specifications.



Please address any potential queries to the authorized representative or directly to the producer LINET spol. s r.o.

## 2 Safety and Dangers

### 2.1 Safety instructions

- ❖ Follow the instructions carefully.
- ❖ Any non-observance of this manual may lead to injuries or material damage.
- ❖ Exclusively use the chair if it is in perfect working order.
- ❖ If necessary, check the chair functions daily or at each shift change.
- ❖ Use the chair exclusively in its original condition.
- ❖ Use the chair exclusively with the correct mains supply.
- ❖ Ensure that the chair is exclusively operated by qualified personnel.
- ❖ Ensure that the patient (health permitting) has been informed about the operation of the chair and all applicable safety instructions.
- ❖ Move the chair exclusively on even, hard-surfaced floors.
- ❖ Replace any damaged parts immediately with original spare parts.
- ❖ Ensure that maintenance and installation are performed exclusively by qualified personnel who have been trained by the manufacturer.
- ❖ Do not apply excess weight or loads to the chair according to SWL (safe working load).
- ❖ During peak loads or unavoidable excess loads (CPR), place mattress platform in the lowest position.
- ❖ Ensure that only one adult patient uses the chair at any time.
- ❖ Take care to avoid injuries or squeezing when operating moving parts.
- ❖ When using lifting poles or infusion stands, ensure that nothing will be damaged when you move or adjust the chair.
- ❖ Ensure that castors are braked when the chair not being moved, regardless of whether the chair is occupied or empty
- ❖ Keep the mattress platform in the lowest position at any time when the healthcare personnel are not treating the patient in order to prevent the patient from falling or injuries.
- ❖ Ensure that siderails are operated exclusively by healthcare personnel.
- ❖ Never use the chair in areas where there is a hazard of explosion.
- ❖ Enable or disable functions on the handset using the supervisor panel as appropriate for the patient's physical and mental state. Verify that the function is actually disabled.
- ❖ Never handle the mains plug with wet hands.
- ❖ Unplug the mains cable exclusively by pulling on the plug.
- ❖ Attachment plug is the only means of disconnecting chair from the mains. It must remain accessible.
- ❖ Position the mains cable so that there are no loops or bends in the cable; protect the cable from mechanical wear and tear.
- ❖ Improper handling of mains cable can cause an electric shock hazard, other serious injuries or damage to the chair.
- ❖ Ensure that the stipulated duty cycle (on-time) is not exceeded (see INT. on product label).
- ❖ Ensure that the moving parts of the chair are not blocked.
- ❖ To prevent failures, use exclusively the manufacturer's original accessories and mattresses.
- ❖ Ensure that the stipulated safe working load is not exceeded.
- ❖ If the patient's condition could lead to an entrapment, leave the mattress support platform in the flat position while the patient is unattended.
- ❖ Do not exceed maximum load of 200 kg for mattress platform extension.

- ❖ Ensure that the chair and its components are exclusively modified with the manufacturer's approval.
- ❖ Ensure there is no risk of crushing or otherwise injuring the patient's limbs (e.g. between siderails and mattress platform, between movable parts etc.) before positioning the chair or folding down the siderails.
- ❖ Do not put any objects (e.g. accessories, infusions, cables) between or on siderails/armrests and movable parts.
- ❖ Use exclusively siderails for confused or disoriented patients.
- ❖ Before setting the lowest position, ensure there is no risk of any parts of the chair colliding with servers, accessories or body parts.
- ❖ Ensure there is no risk of damaging the cables of supervisor panel or handset when they are stored on siderails or chair ends.
- ❖ To prevent collisions, do not put oxygen bottle holders directly under mattress platform.
- ❖ Always set mattress platform to its lowest position and single parts of mattress platform to horizontal position in case the patient is left on the chair without supervision of personnel and if his health and mental status may indicate increase risk of falling out of the chair or entrapment.
- ❖ Personnel must consider overall adjustment of the chair and locking all of the positioning functions in accordance to health and mental status of patient, especially if the patient is left without supervision (even for short period of time) of the personnel.
- ❖ Pay attention to the correct fastening and positioning of the accessories.
- ❖ Do not carry out unqualified disassembly and repairs of the motors, the control panel etc.
- ❖ The chair should not be used in explosive environments.
- ❖ Structural modifications reserved!
- ❖ In order to prevent fires related to flammable substances and anesthetics during minor surgical procedures using high frequency (HF) equipment it is necessary to put the chair in equipotential connection with other medical devices.
- ❖ Never use accessories which are not original. Every original accessory is marked by an original label containing the name and trademark of the manufacturer, the product marking and the code barring other information: (production number or the ID of the batch, data of production).
- ❖ **Any serious incident that has occurred in relation to the device should be reported to the manufacturer and the competent authority of the Member State in which the user and/or patient is established!**
- ❖ **Only authorised and trained person using the tool is allowed to change fuses and power supplies!**
- ❖ **This medical device is not intended for oxygen enriched environment!**
- ❖ **This medical device is not intended for use with flammable substances!**
- ❖ **This medical device is not portable medical electrical equipment!**
- ❖ **Make sure the duty cycle (2 min ON/18 min OFF) is not exceeded during bed positioning!**
- ❖ **Patient is allowed to use selected control elements only if hospital personnel had assessed that the patient's physical and psychological state is in accordance with use of them and only if the hospital personnel had trained the patient in accordance with the instructions for use!**
- ❖ When handling the chair on an uneven surface (overcoming the tilt or inclination of the surface, sloping surface, etc.) it is recommended to operate the chair by two people.

## Fire Extinguishing Information

	<b>Warning: Note</b>
<p>Danger of frostbite by contact of CO2 with human skin!</p> <p>Do not use halotron extinguisher in closed rooms without ventilation – danger to your health!</p>	

The medical product is categorised as energised electric installation, hence, fire can be extinguished by the following types of extinguishers.

Use	Do not use
Powder extinguisher	Foam extinguisher
CO2 extinguisher	Water extinguisher
Halotron extinguisher	



## 3 Un-packing Manual

### Shipment inspection after delivery

Do not unpack and/or accept the shipment if the package is clearly damaged! If that is the case, file a complaint.

### Personnel qualification

Persons authorised to install the product and put it into operation, i.e. persons trained by L I N E T spol. s r.o.

### Personnel required for unpacking and installation

At least two persons.

### Time estimation

Unpacking is estimated to take 20 minutes; installation is estimated to take 20 minutes.

### Tools and materials needed

Scissors / knife.

### Required workspace

When unpacking, pay attention to the overall dimensions of the chair. Recycle used packing material. We recommend unpacking and installation at the goods receipt point. When unpacking, leave at least 0.8 m of space on both sides of the pallet and at least 2.6 m (minimum unpacking space is 2.8 x 5.2 m).

### Instructions

Cut the safety tape.



Remove the top of the packaging and the corner of the box. Cut off the corners of the outer reinforcement or crush them with your foot so that you can pull the chair out of the pallet easily. Carefully cut through the plastic packaging.



Version with side rails: the side rails are in a down position. Cut the tightening straps and remove the mirelon tubes.



Version with armrests: the armrests are placed horizontally, they do not touch the chair. Cut the strap to release them. Gradually pull all accessories out of the packaging and cut-outs, remove the empty packaging from the pallet and dispose of it.

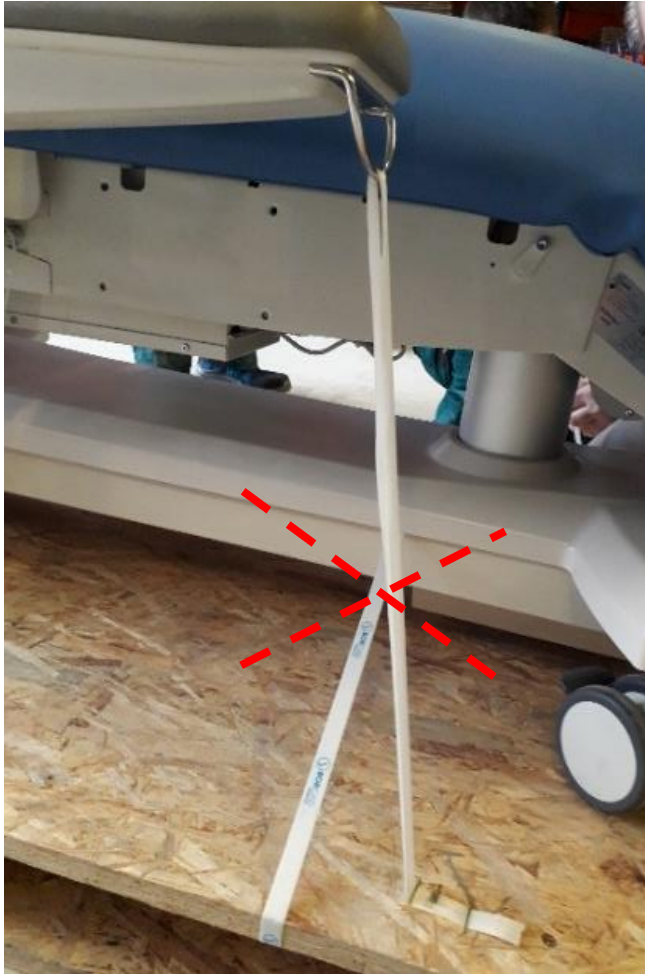

Cut off the tightening straps from the hand control and the power cable and remove the mirelon tubes at the bottom frame.

Cut off the tightening straps from the footrest.

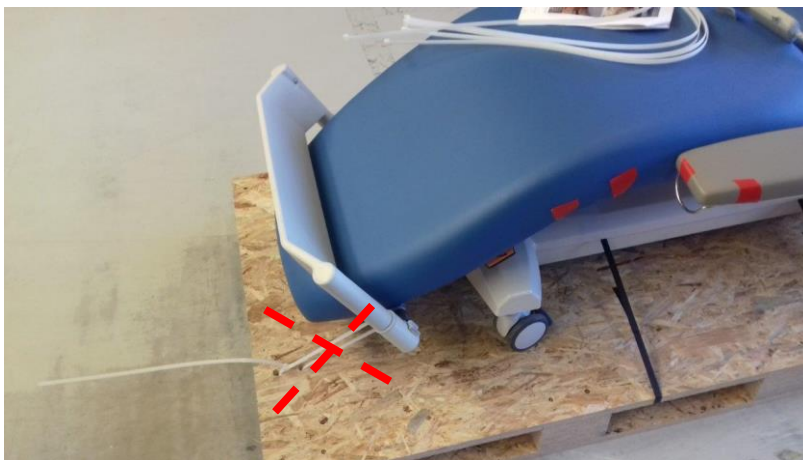

Cut off the tightening straps at the back part and remove the mirelon tube.



Cut off the tightening straps holding the chair's chassis together with the pallet and release the brake of the wheels. Then the chair can be carried by two persons from the pallet and placed on the ground.



## 4 Overview of basic parts

1. Back section with non removable upholstery
2. Seat section / leg section with non removable upholstery
3. Adjustable armrests
4. Base of the chair with lifting columns
5. Lockable castors – 100 mm diameter
6. Castors with central brake – 150 mm diameter
7. Adjustable siderails
8. Pillow (option)
9. IV pole holder (option)
10. Head bumper, transport handle
11. Adjustable leg rests (option)

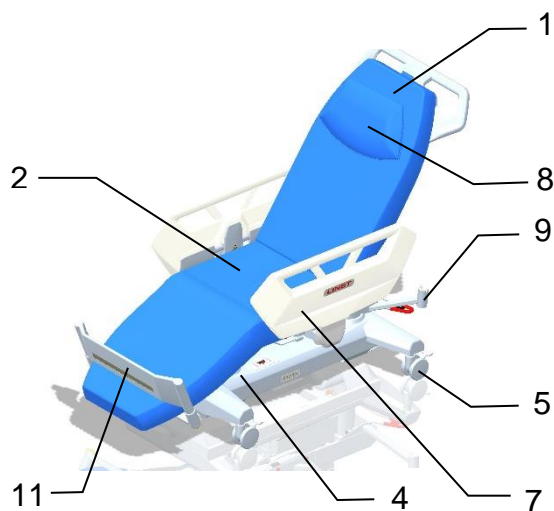

### 4.1 Overview of basic versions

<b>10DAA</b>	Version with siderails
<b>10DAB</b>	Version with armrests

## **4.2 Safety**

### **Standards**

The product meets the requirements of valid standards EN 60601-1 ed. 2 and IEC 60601-1-2 ed. 3. According to the current text of the Directive on Medical Instrumentation 93/42/EEC, the chair is classified as class I medical device, non-sterile, without measuring function.

### **The chair complies with the following standards and directives:**

- EN 60601-1:2006/A1:2013
- EN 60601-1-2:2015
- EN 60601-1-6:2010
- ISO 10993-5:2009
- ISO 10993-10:2010

### **The manufacturer adheres to a certified quality management system in compliance with the following standards:**

- ISO 9001
- ISO 14001
- ISO 13485

## 5 Function



### Warning: Caution

The essential functions are lying, sitting and supporting the patient during procedure. Additionally, it is the CPR position.

The use of the chair is allowed only on the premises that comply with the conditions of the applicable regulations for electrical installations in premises for medical purposes. In accordance with the provisions of the law on medical devices, the product can be used only by appropriately qualified users.

For service assistance: the authorized service centre of L I N E T spol. s r.o. can responsibly evaluate technical and safety properties only if the use, repairs, changes etc. have been carried out in centres approved by the manufacturer and the product is used in a manner fully compliant with this manual

### 5.1 Interaction

When using the chair as part of the medical system, certain elements (medical devices) may interact. Before this application it is necessary to follow recommendations provided in the user manual of the chair.

### 5.2 General instructions

Chair is intended for use in the Application Environment 5 (acc. to IEC 60601-2-52).

### 5.3 Application environment 5

Outpatient (ambulatory) care, which is provided in a hospital or other medical facility, under medical supervision and me equipment, is provided for the need of persons with illness, injury or disability for treatment, diagnosis or monitoring.

Manual positioning of parts of the chair which are designed for electronic positioning (e.g. back rest) is forbidden. Otherwise there is a risk of damaging and dysfunction of the back rest actuator or unprompted fall of the back rest.

## 6 Intended use

The chair complies with the demands for chair before and after the day surgery operation (patient admission, transport, recovery after surgery) and for non-invasive procedures such as Colonoscopy/ Gastroscopy endoscopic examination, Operation of Hallux Valgus deformities, Surgical Treatment of small burns.

The chair complies with the demands of treatment processes in terms of dialysis/oncology/blood donation.

The essential functions are lying, sitting and supporting the patient. The chair serves for several-hour-rest of a patient during a treatment process. The chair is equipped with adequate accessories and offers the patient the opportunity to rest in optimal – comfortable position during the procedure. The practitioner and the staff have maximum support for their work.

### 6.1 User population

- The chair is primarily intended for adult patients (male/female) from age of 15 and up to 190 kg
- Suitable in a variety of clinical settings including nursing homes, ICU, emergency, one day care, acute care (med-surge)/ geriatrics and rehabilitation centers by adult patients/residents
- Caregivers & patients (nurses, nursing assistants, doctors, technical personnel)

### 6.2 Contraindications

- Absolute contra-indication is the use of the chair for planned day surgery invasive operations, when it is possible to perform the surgery in a standard operation room with adequate equipment.
- The chair does not replace a stretcher.
- The medical device is not intended for pediatric patient use.
- Not suitable for patients who exceed the maximum patient weight indicated in the instructions for use or have impaired sitting balance.
- In case of having cognitive impairments, confusion, delirium such that they may try to stand up on the foot plate and walk.
- In case of severe tissue damage at the sacral level, pressure injury risk management should define the length of stay in the chair.
- Clinical judgment should be exercised when seating with pressure injuries to the sacrum, coccyx, ischia with regards to the suitability of the seating surface and length of time sitting.
- Sedated patients should be supervised at all times.

### 6.3 Operator

- Caregiver
- Patient (based on individual patient status assessment by caregiver the patient can utilize dedicated device functions)



## 7 Electrical safety



### Warning: Dangerous electric voltage

The arm-chair mustn't be used in medical premises with potential danger of fire or explosion caused by air, environment with enriched oxygen, or with monoxide nitrogen in combination with anesthetic or cleaning agents.

Since the unit is powered from the network, it may cause interference with sensitive equipment due to generation of electromagnetic field. In order to reduce the influence of undesired electromagnetic effects, the chair was designed in compliance with AAMI/ANSI/IEC 60601-1-2. To prevent the occurrence of these problems the chair must be used in compliance with this manual.

To avoid risk of electric shock, this chair must be connected to power main with protective earthing.

The chair must be positioned in such a way so that it could be immediately disconnected from the power main if necessary.

If there is a fluctuation in the voltage range, then it is necessary to connect the product to voltage regulator. Otherwise the electronics can be damaged!

The chair may cause radio interference, which can affect function of nearby device. It may be necessary to take measures to reduce these effects, such as redirection, relocation or shielding of the device.

Portable and mobile HF communication equipment can influence chair functions.

Medical electrical equipment or medical electrical system should not be used in extremely short distances within the chair! In the case it is necessary to use medical electrical equipment in this extremely short distances within the chair observe this configuration regularly to verify the normal functions of the chair in this configuration.

Consult L I N E T spol. s r.o. or local dealer before using medical electrical equipment where influence on the chair can be strong.

NOTE AAMI/ANSI/IEC certified medical electrical equipment used in ICU is not restricted.

NOTE It does not concern fixed installations of hospital communication systems and nets (DECT, pager, WiFi) and other mobile devices which are certified according to local telecommunication legislation

The chair must be installed and put into operation in compliance with information related to EMC provided in the accompanying documentation. Portable and mobile HF communication devices may influence the electrical medical device.



**Warning:  
Dangerous electric voltage**

Do not wrap the power cable around the chair and its parts – front part, barriers, armrests, transport handles and others!

When lifting the chair or its back part, there is a risk of cable tear! Risk of electric shock or fire!

In case of visible damage to the cabling, do not tamper with the chair or the cable! It is always necessary to call service technicians!

The mains power cable must be always attached to a selected place on the chair with a plastic hook!



## 7.1 Electromagnetic compatibility

Chair is intended for hospitals except for near active HF surgical equipment and the RF shielded room of a medical system for magnetic resonance imaging, where the intensity of EM disturbances is high.

Chair has defined no essential performance.

### **WARNING!**

It is recommended to avoid the use of this device next to or in block with other device, because it could lead to improper operation. If such use is needed, this device and the other equipment should be under surveillance to verify proper operation.

#### List of used cables:

1. **Mains cable**, maximum length 6 m

### **WARNING!**

Use of the accessories, converters and other cables, than specified and provided by manufacturer of this chair could lead to increase of electromagnetic emission or lower the electromagnetic immunity of this chair and lead to improper operation.

### **WARNING!**

Mobile RF communication device (including end use devices like antenna cables and external antenna) should not be used closer than 30 cm (12 inches) from any part of this chair, including cables specified by manufacturer. Otherwise this could lead to deterioration of functionality of this chair.

### **WARNING!**

Do not overload the chair (SWL), respect the duty cycle (INT.) and consider chapter Maintenance in order to maintain the basic safety with regard to electromagnetic disturbances for the expected service life.

#### Manufacturer instructions – electromagnetic emissions

Emission test	Compliance
RF emissions CISPR 11	Group 1
RF emissions CISPR 11	Class B
Harmonic emissions IEC 61000-3-2	Class A
Voltage fluctuations / flicker emissions IEC 61000-3-3	Complies

## Manufacturer instructions – electromagnetic susceptibility

Immunity Tests	Compliance level
Electrostatic discharge (ESD) IEC 61000-4-2	± 8 kV for contact discharge ± 15 kV for contact discharge
Radiated RF IEC 61000-4-3  Proximity fields from RF wireless communications equipment IEC 61000-4-3	3 V/m 80 MHz – 2,7 GHz 80 % AM at 1 kHz  See Table 1
Fast electrical transients / burst IEC 61000-4-4	±2 kV for power line repetition frequency 100 kHz
Surge IEC 61000-4-5	± 1 kV Line-to-line ± 2 kV Line-to-ground
Conducted RF IEC 61000-4-6	3 V (0,15 MHz – 80 MHz) 6 V in ISM bands between 0,15 MHz and 80 MHz 80 % AM at 1 kHz
Power frequency (50/60 Hz) magnetic field IEC 61000-4-8	30 A/m
Voltage dips, short interruptions on power supply input lines  IEC 61000-4-11	0 % U <sub>T</sub> ; 0,5 cycle At 0°, 45°, 90°, 135°, 180°, 225°, 270° a 315° 0 % U <sub>T</sub> ; 1 cycle and 70 % U <sub>T</sub> ; 25/30 cycle Single phase: at 0° 0 % U <sub>T</sub> ; 250/300 cycle

**Table 1 – IMMUNITY to RF wireless communications equipment**

Test frequency (MHz)	Band (MHz)	Service	Modulation	Immunity test level V/m
385	380 - 390	TETRA 400	Pulse modulation 18 Hz	27
450	430 - 470	GMRS 460, FRS 460	FM ± 5 kHz deviation 1 kHz sine	28
710 745 780	704 - 787	LTE band 13, 17	Pulse modulation 217 Hz	9
810 870 930	800 - 960	GSM 800/900, TETRA 800, iDEN 820, CDMA 850, LTE band 5	Pulse modulation 18 Hz	28
1 720 1 845 1 970	1 700 - 1 990	GSM 1800; CDMA 1900; GSM 1900; DECT; LTE band 1, 3, 4, 25; UMTS	Pulse modulation 217 Hz	28
2 450	2 400 - 2 570	Bluetooth, WLAN, 802.11 b/g/n, RFID 2450, LTE band 7	Pulse modulation 217 Hz	28
5 240 5 500 5 785	5 100 - 5 800	WLAN 802.11 a/n	Pulse modulation 217 Hz	9

**NOTE** There are applied no deviations to requirements of IEC 60601-1-2 ed. 4

**NOTE** There are no known other measures for keeping the basic safety based on EMC phenomena.

## 7.2 Mechanical safety



### Warning: Caution

- No objects that may collide with the chair (furniture, stands etc.) may be located near it.
- Never put any extra objects under the mattress platform.
- No person are allowed to retain under the chair.
- Never enter the space under motor operated parts of chair (back, seat and leg rests).
- Before undertaking any resetting of the multifunctional chair check if no one is within reach of the moving parts.
- Before any resetting, check for kinked and/or tangled power cables.
- After setting the chair in place, all brakes must be engaged so as to prevent unwanted movement of the chair, e.g. during patient's occupancy. When setting the chair all four castors have to be in contact with the floor and the brakes engaged.

## 8 Setting the product

- Before the patient seat section on the multifunctional char the char has to be positioned-locked safely!
- The multifunctional chair cannot be transported in the Trendelenburg position.
- The multifunctional chair PURA is equipped with 4 castors with brakes that must all be blocked so that the chair can stay steady on the floor
- To brake all castors in the version you use the central brake.
- Nearby the armchair should not be placed any objects (furniture, easels etc.) that might collide with it.
- Never touch and never entry into the space under the engines parts of the supporting area (back section, seat section and leg rest).
- When fastening the multifunctional chair it is necessary to pay attention so that all 4 castors are in contact with the floor – are properly fixed.
- Before connecting, check the condition of the power cord - it must not show any mechanical damage.
- Before connecting to the mains, check that the mains voltage corresponds to the data on the label of the multifunctional chair.
- Within a distance of 1.50 m within the patient space you can use only medical devices which comply with the requirements of EN 60601-1 or a medical device certified according to IEC.
- The power cable must not be connected through an extension but directly into the socket.
- The chair must be connected to the mains and left at least 10 hours connected to the mains so that the backup battery is loaded to its full capacity.
- The chair includes firmware that can be updated only by an authorised service technician.
- This firmware is protected against unauthorised access by mechanical housing (tool is needed to access), by seal (components with processor are sealed), by exclusive compatibility with an authorised software tool and by check of compatibility of the new firmware with the chair.
- All seat tilt functions are controlled by a control unit that evaluates the current seat tilt relative to the horizontal.

### **L I N E T spol. s r.o. recomend to set up the chair in to Welcome position before every new patient:**

- Straight "horizontal" position at the lowest possible height of the chair.
- The foot section is extended and set in the highest position, where it serves as a lying area.
- The bed is covered with emergency sheets / disposable covers.
- The side guards / armrests are in the "active" position and serve as a safety element.
- The wheels are braked with a central brake.
- The staff always briefly instruct the patient on how to use the chair (control the basic functions, the chair's adjustment) and showing the warning labels.

## 8.1 Transport, braking

The chair also allows for the transport of a patient. This is, however, subject to the following conditions:



### Warning: Caution

Transport the chair in its lowest position and make sure that it is not transported over areas with lateral inclination exceeding 6°. Always use the transport handles. In case of interrupting the transport (stopping the movement of the chair), always secure the chair with the central brake. Otherwise you can cause injury to persons or damage to the device.

It is not recommended to position the moving parts of the loading surface of the chair if the chair is on an inclined plane.

Before transporting the patient, always make sure that the patient is securely seated in the chair and that there is no risk of the patient falling out or injured during transport.

The maximum threshold crossing height is 20mm.

The chair allows for the transport of a patient by pushing forward using the handle on the back section. Before transporting the patient, disconnect and store the power supply cables and equipotential and other connections properly, to prevent their tearing off. Use the handle on the back section only to transport the chair. Do not transport the patient if the chair is set in the chair position. If you do so, you can cause injury to persons or damage to the device. Before transporting the patient, the central brake must be released.

When transporting the patient, the locking pedal must be used to secure the front directional castor in a straight direction. Optional lamp must be turned off, charging of mobile phone should be switched off. Otherwise the patient has to be transported by two persons.

When transporting optional lamp must be turned off, charging of mobile phone should be switched off to keep battery back up fully charged for more important movements of chair (high adjustment, tilting etc.)

When transporting the chair within hospital premises, make sure that the patient as well as all equipment, such as cables (including the power supply cable), hoses, tubes, etc., are safely placed in the area bounded by the circumference of the chair. Otherwise you can cause injury to persons or damage to the device.

During transport, check the stability of the infusion stand - it can hit doors or ceiling lights. Before transporting the patient, set the stands to the lowest position. Otherwise you can cause injury to persons or damage to the device.

After the transport, reconnect the power supply cable and secure the chair with the central brake. Otherwise you can cause injury to persons or damage to the device.

Do not expose the chair to prolonged extreme effects of external environment (snow, frost, rain, etc.). It could damage the device.

During transport, pay attention to the footrests, side guards, foot section and handles to prevent impacts on doors and other objects. Failure to do so may result in personal injury or equipment damage.

#### Suitable floor:

- Floor tiles
- Hard linoleum
- Cast floor

#### Unsuitable floor:

- Too soft, not sealed or defective flooring
- Soft wood floor
- Soft and porous artificial stone floors
- Carpets with lining
- Soft linoleum
- When transporting the chair at a distance, check the castor control is active (main control lever).
- Release the brake before transporting the chair.

The chair is fitted with four castors (150mm version) and it may be moved in all directions. Castor functions are controlled by pedal brakes.

Setting of the wheel pedal:

<b>Backward</b>	All castors locked
<b>Horizontally</b>	All castors free, spinning around their axle
<b>Forward</b>	Left castor locked (patient on the chair view) in forward direction, other castors free, spinning around their axle.

## Symbols meaning of arrest control pedals:

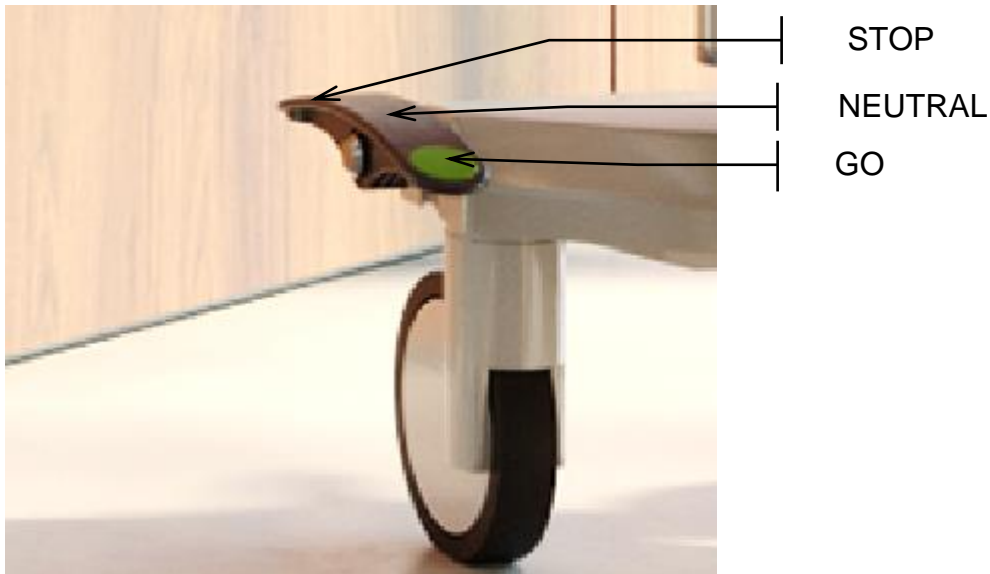

The chair is fitted with four castors (100mm version) and it may be moved in all directions. Castor can be blocked individually.

Setting of the wheel pedal:

<b>Upward</b>	Castor is unlocked
<b>Downward</b>	Castor is locked

## Symbols meaning of arrest control pedals:

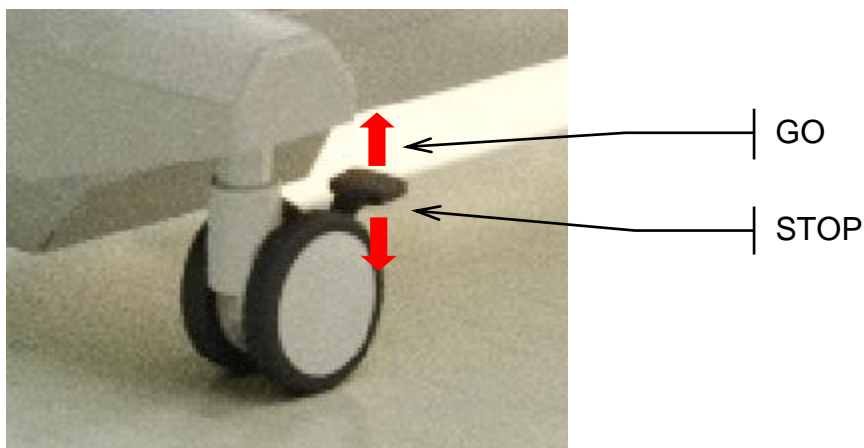

## 8.2 Transportation of the chair from one place to another

Follow the instruction below:

- Do not move the chair over cables.
- Power cable of the chair must always be fixed in the hook.
- Unlock the castors before travelling (see castor control and transportation).
- Do not move the chair on floors with unsuitable surfaces.

The chair can be transported from one hospital to another without the pallet and/or further transport aids.

1. Lift the back in an angle of approx. 30°
2. Fold down foot section.
3. Put the siderails/armrest to active position
4. Tilt infusion stand holder to parking position or if it is fixed carefully watch when transporting.
5. Load the chair to transport car, ramp
6. Brake the chair
7. Tie down the chair





## 9 Operating the chair



### Warning: Caution

- The multifunctional chair is not intended for continuous use - motors can withstand the maximum loads values reported on the label, or 2 minutes of continuous use (e.g. continuous positioning of the chair) and then 18 minutes of rest. In case of overload automatic shutdown of operation can occur. After that a service intervention is required.
- If multifunctional chair includes the backup battery, than fully battery (properly charged) allowed using the chair for about 1 minute. The battery is automatically powered by the control unit and does not require any particular maintenance regime, except in cases where the chair is not connected to the mains for over a week and it is necessary to disconnect the battery connector from the CB (Control box).
- The product components do not have any particular fire extinguishing property. For this reason, be careful in case of open flames near the product. Otherwise, the product may catch fire.
- Before any movement of the multifunctional chair make sure that other people are not within reach of the moving components.
- Before any movement of the multifunctional chair check that the power cables are not pressed.
- Before movement with back section, please check if the back section is not in colision with a wall, furniture or other colisions.
- In the event of failure of the hand controller (button continuously pressed or cable damage) it is possible to stop powering by pressing the button for reverse operation, after that it is necessary to disconnect the power cable and the batteries and contact the service centre.
- When you manipulate the product pay particular attention to the protection of the power cable so that there is no mechanical damage to the insulation.
- In case of replacing the fuses, check the correct position of the fuse. To replace a fuse you don't need necessarily a service centre of L I N E T spol. s r.o. the operation can also be performed by a specialist in the electricity sector.
- Never hang the not connected power cable to the moving parts of the chair. Work on the backup battery may cause damage!
- The power cable must not pass over the chair nor over the patient (customer).
- Beware of the free movement of tubes, cannulas and other loose mobile parts (if used for example for the IV) so that they are not pressed in the moving parts of the product (armrests or folding parts of the product might be point of possible collision).
- Collisions with surrounding objects may occur during positioning. It is recommended to keep a safe distance from other objects so as to avoid collisions between them.
- The backup battery is intended only for the operation of emergency in case of a power failure, not for current operation.
- Both armrests contain eyelets to attach the hand controller. Putting the hand controller in this position when not in use you can avoid situations of mishandling that may cause damage to the hand controller.

## 9.1 Motor setting

The hand controller is very intuitive, ergonomic design and standard feature. It contains basic positions of chair sections (back section, foot section, and foot support), up/down and chair inclination. It also offers functions such as lock position, GO button, Trendelenburg, indication of the battery status, indication of connection to mains, STOP button and memory functions (horizontal and access position).

**Storage location for handcontrol see picture, any other location is not allowed!**

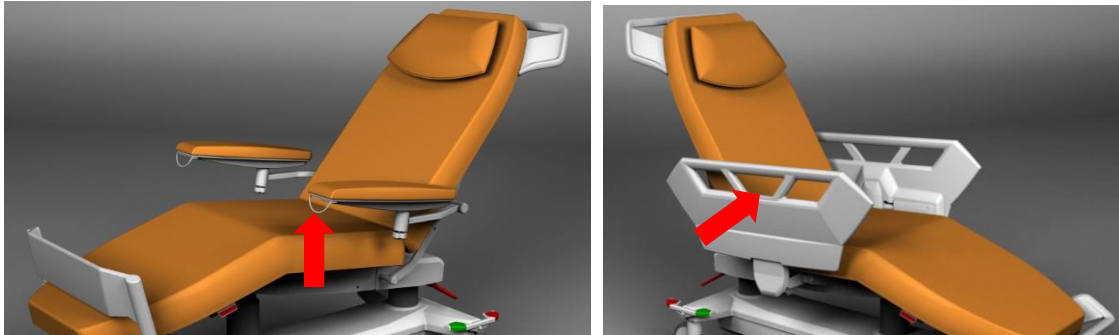





### Explanation of LED diodes

Power On – green control light on the hand controller	
Turned off	Chair not connected to the electricity
Always on	Chair connected to the mains, battery charged ready for use

### Explanation of acoustic signals

Beep sound during operation
The battery is almost completely discharged (less than 30%), in few moment the chair will stop working. Connect immediately the chair to the mains

	<p><b>GO button</b></p> <p>The GO button is used to turn on the time interval in which other functions on the control can be used. The GO interval ends 3 minutes after the control was used the last time.</p> <p>Next to the GO button, there is a LED indicator of the active GO periods (the time interval in which the control functions can be used). This is the LED next to the GO button which is on during the active GO period; light is off outside the GO period; when the GO period is not on and the button of the blocked GO function is pressed, the indicator flashes while pressed. It is impossible to set the chair into positions at this moment!</p>
	<p><b>STOP button</b></p> <p>Pressing the button stops all chair movements. After pressing another function button, the chair then moves to the desired position again.</p>
	<p><b>Battery status indication</b></p> <p>Off – the battery is charged          Flashing (light is on briefly, not for long) – battery charging in progress          Flashing (light is on longer, not briefly) – battery voltage very low          Flashing fast – battery voltage drops          Light continuously on – the battery is not detected (missing battery, disrupted supply, defective fuse)</p>
	<p><b>Network connection indication</b></p> <p>The LED light is on when the chair is plugged into the mains.          The LED light is off when the chair is not plugged into the mains.</p>
	<p><b>LOCK button</b></p> <p>To lock all chair movements, press the button on the hand control. The corresponding LED on the hand control switches on. To unlock all chair movements, press the button on the hand control and hold it down. The corresponding LED on the hand control is turned off.</p>

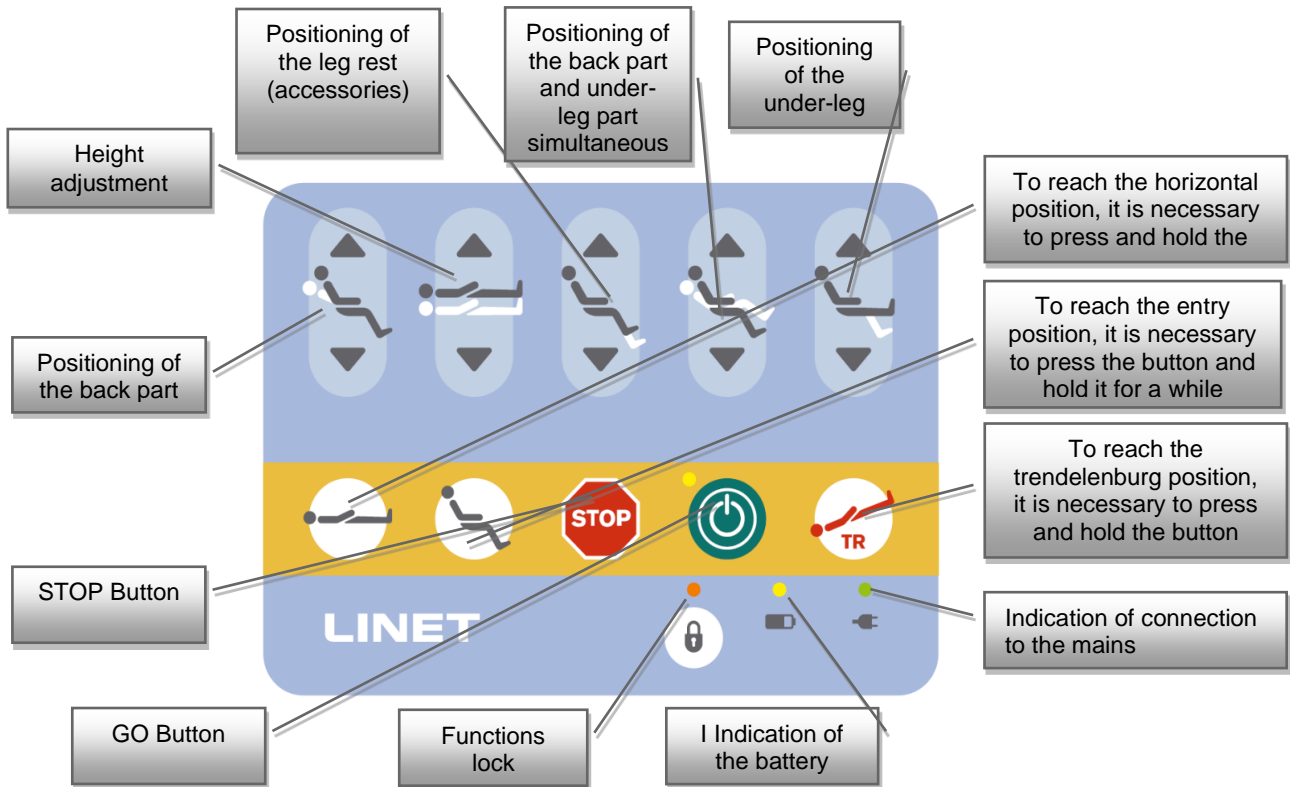

## 9.2 Armrests

### 9.2.1 Basic armrest



**Warning:  
Caution**

The armrests are adapted for a maximum load – see Technical parameters. In case of overload (such as when sitting on the armrests) this component may lose their functionality. We strongly recommend that you respect the maximum load of the armrest.

#### Vertical positioning

By pressing the adjusting lever located on the front of the armrest while pressing at the same time on the armrest you can set the armrest to the lower position. With the reverse movement (control lever always pressed on the front of the armrest) – by pulling we can set the armrest until the horizontal position.

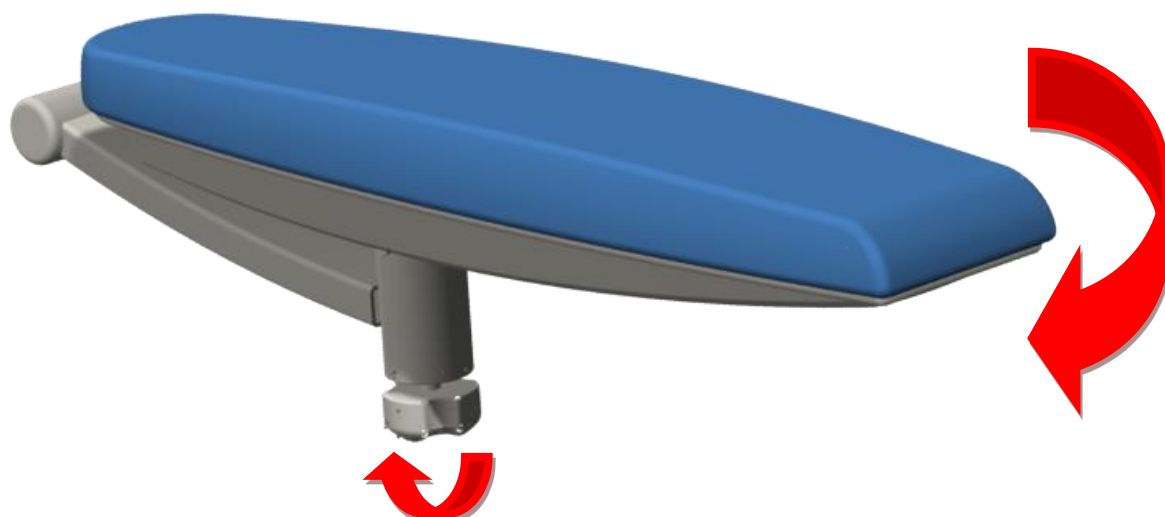

#### Horizontal positioning

Each armrest can be adjusted horizontally to the side just by lifting the armrest and then rotating it until the desired position. In this way, we can adjust the armrest in a total of 5 preset positions.

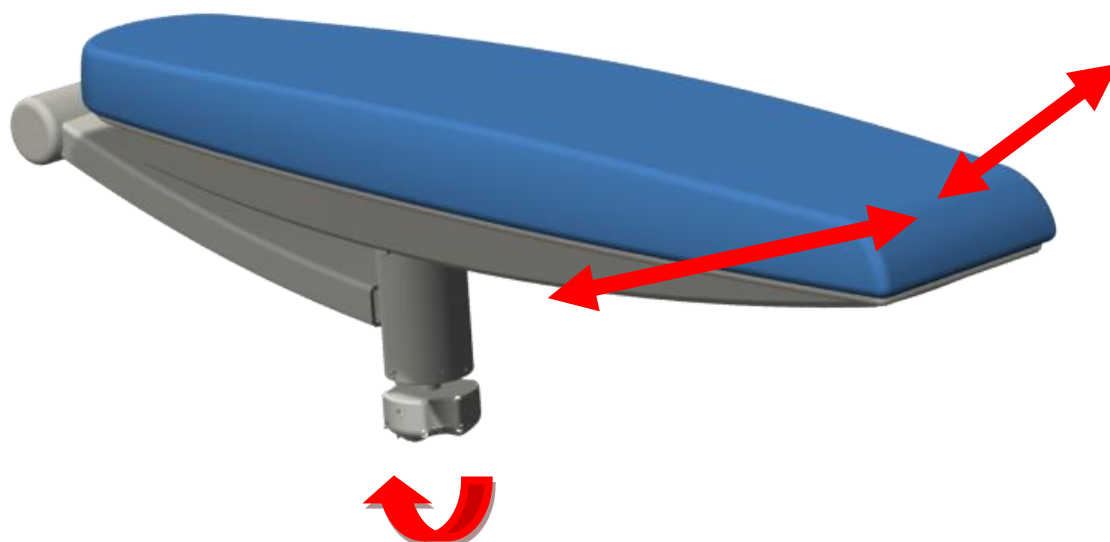

## 9.2.2 Improper adjustment of the armrests



### Warning: Caution

Make sure that the armrests are adjusted correctly, including the height-adjustable armrests and the armrests with the elbow relief. Improper use of the armrests will damage the backrest upholstery and the back part upholstery. A claim due to damaged upholstery caused by improper adjustment (see Fig.1 and Fig.2) will not be accepted during the warranty period.

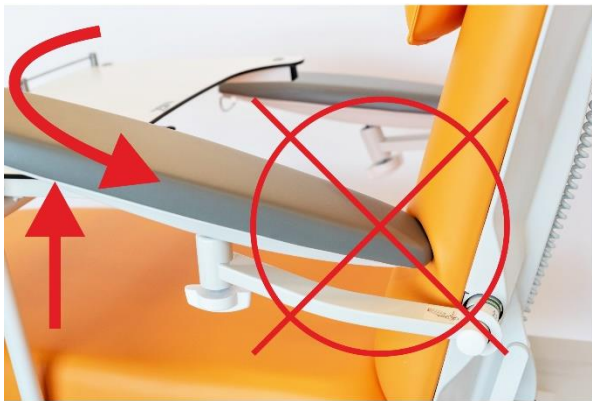

Fig. 1

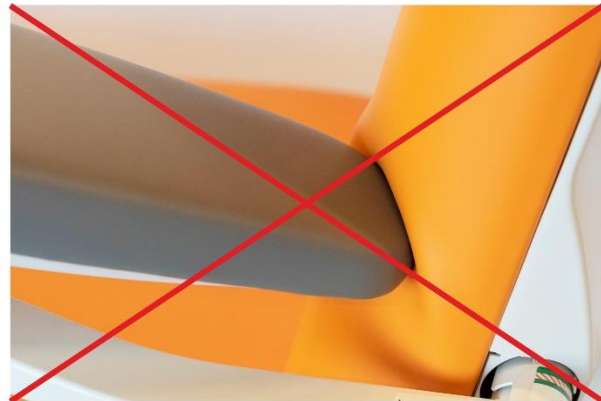

Fig. 2

## 9.3 Siderails



**Warning:  
Caution**

**Risk of injury due to patient falling out of chair!**

- Ensure that folded-up siderails are securely anchored.
- Press against siderails from inside in order to check stability.
- Hospital personnel are responsible for ensuring siderails are folded-up when the chair is occupied.

The split plastic siderails are components of the chair, the siderails cannot be removed.

**To fold siderails down:**

Take hold of the siderail handle and push siderail towards mattress platform 1.  
Pull out locking mechanism 2 to unlock.  
Fold siderail down 3.



**To fold siderails up:**

Grip the siderail by the siderail handle. Pull siderail up until it latches. The locking of each siderail is indicated by an audible 'click' when locked in place. Ensure that the siderail is locked properly.

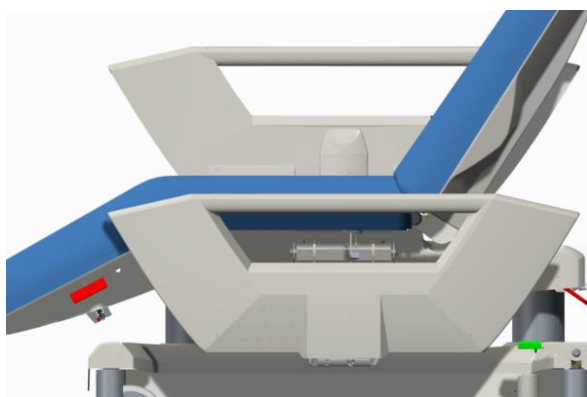

## 9.4 Electric setting of Trendelenburg



**Warning:  
Caution**

The optional equipment of the arm-chair contains a backup battery, which serves to set the chair into the anti-shock position in case of a power outage.

To set the Trendelenburg position press (and keep holding) the button on the remote control. In this way the anti-shock position can be set starting from any previous position of the chair. To reset the back section to its original position, use motoric positioning (activates via hand control).

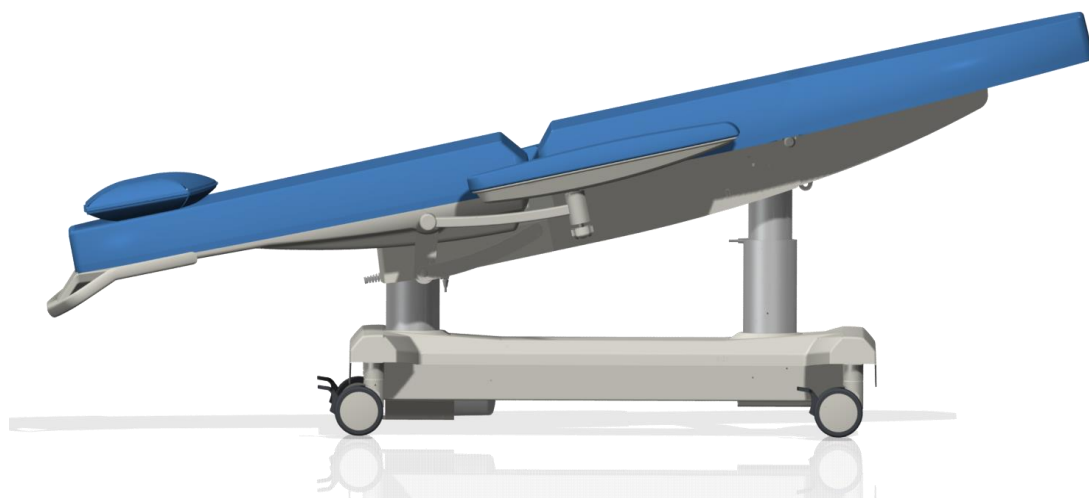
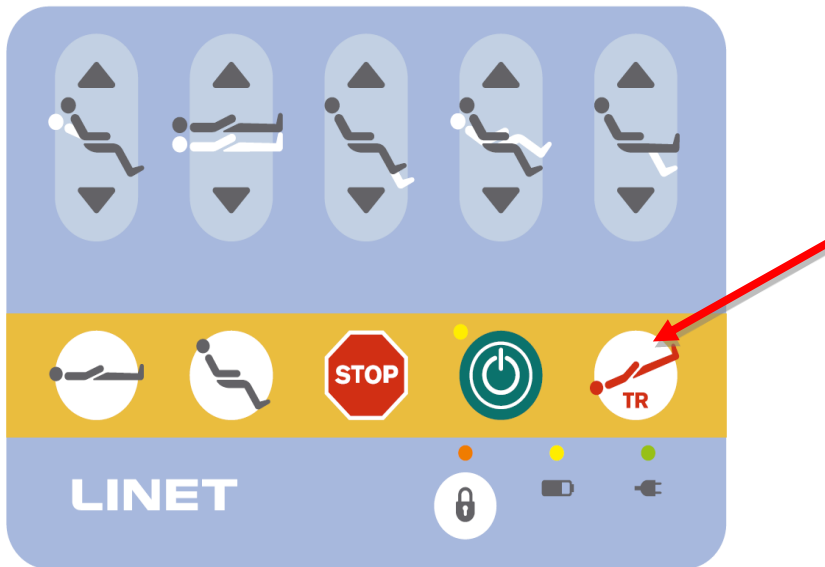



## 9.5 Equipotential bonding

The chair is fitted with a coupling for synchronizing the potential with other electrical medical equipment. The coupling is located behind the chair under the lying surface of the chair. The chair is interconnected to the other device by means of a cable (not supplied with the chair) that is connected easily by its end to the coupling.

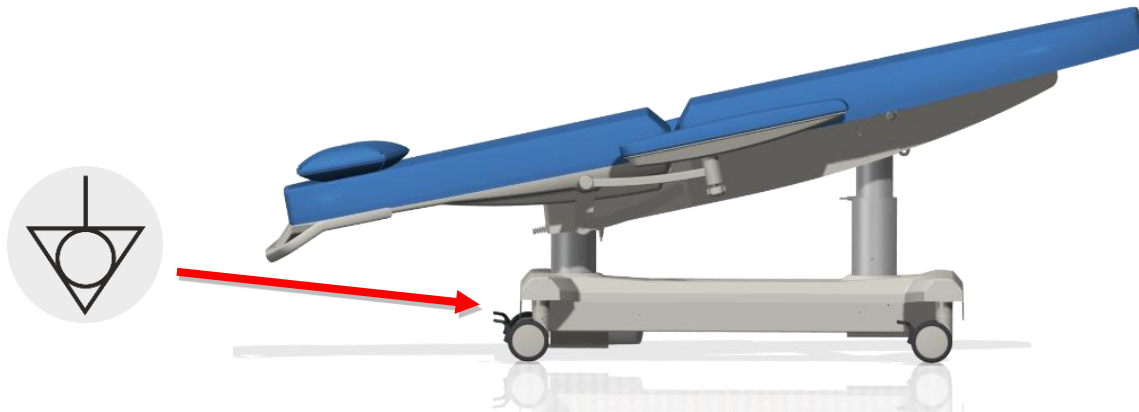

## 9.6 Rear head bumper

Rear chair-head represents a safety element of the chair and can be used by personal during transport as the transport handle.

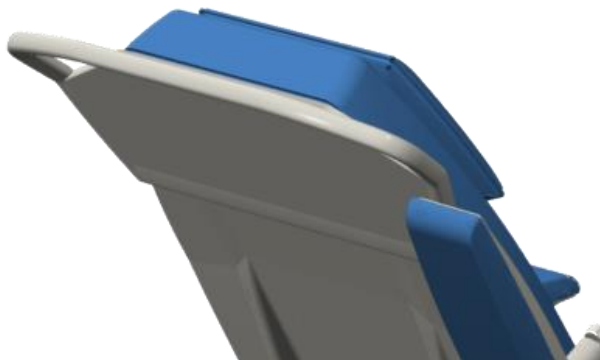

## 10 Accessories



**Warning:  
Caution**

Never put removable accessories onto the arm-chair, onto its loading area, onto the bottom cover or over a patient. Otherwise you can cause injury to persons or damage to the device!

### 10.1 Rotary holder of the infusion stand



**Warning:  
Caution**

The maximum loading is 8 kg!

The adjustable infusion holder is used for fixing the infusion stand. It offers two positions - "parking" and "active". To fix the holder in the "active" position, draw the holder toward you. To return the holder back to the "parking" position, repeat the procedure in the opposite order (it is only valid for the version with elbow-rests).



### 10.2 Firm holder of the infusion stand



**Warning:  
Caution**

The maximum loading is 8 kg!

The inseparable infusion holder is used for fixing the infusion stand. It offers one "active" position (it is only valid for the version with barriers).



## 10.3 Pillow (flat)

A comfort height-adjustable head rest provides a support for a patient's head. A pillow with a leatherette band can be easily demounted.



## 10.4 Pillow (half-round)

A comfort height-adjustable head rest provides a support for a patient's head. A pillow with a leatherette band can be easily demounted.



## 10.5 Pillow (for lying on the side)

A comfort adjustable head rest provides a support for the patient's head which lays on the arm-chair on his/her side. The pillow is not fixed on the arm-chair, it is possible to take it off.



## 10.6 Pillow (between the back and seat parts)

The pillow increases patient's comfort in the area of his/her thighs, mainly in a horizontal position of the arm-chair. The pillow can be easily unfastened from the both sides of the arm-chair by unhooking from the pin.



## 10.7 Big plastic box for personal things



**Warning:  
Caution**

The big plastic box cannot be combined with the oxygen bottle holder!

The maximum loading is 8 kg!

It serves for putting patient's personal things into it. The vessel volume is 20 l. Dimensions (length: 42 cm, height: 23 cm, width: 30 cm).



## 10.8 Small lockable box for personal things



**Warning:  
Caution**

It is not possible to combine the lockable box and the holder for an urine bag on the same side of the arm-chair.

It is designed for locking small patient's personal things such as keys, telephone, wallet. The box includes keys for the lock.



## 10.9 DIN lath



**Warning:  
Caution**

While moving the arm-chair up and down, please make sure that ambient things are not in collision with or cannot be captured by this holder.

The maximum loading is 50 kg at the maximum outreach of 200 mm!

The holder is used for the placement of the certain accessories such as, for example, an additional rest, infusion stand and surgical trays.

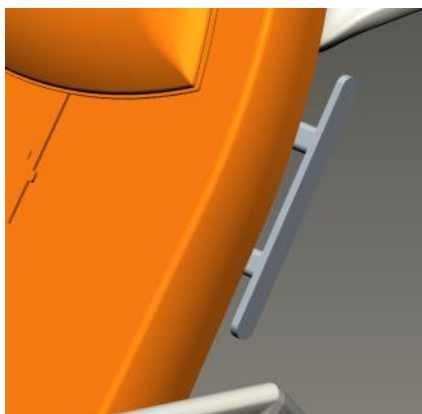

## 10.10 Paper roll holder



**Warning:  
Caution**

It is only designed for a paper roll!

It serves neither for any manipulation with the arm-chair nor as a transport handle!

The maximum load is 2 kg.

The paper roll holder (for the maximum roll with a length of 50 cm).

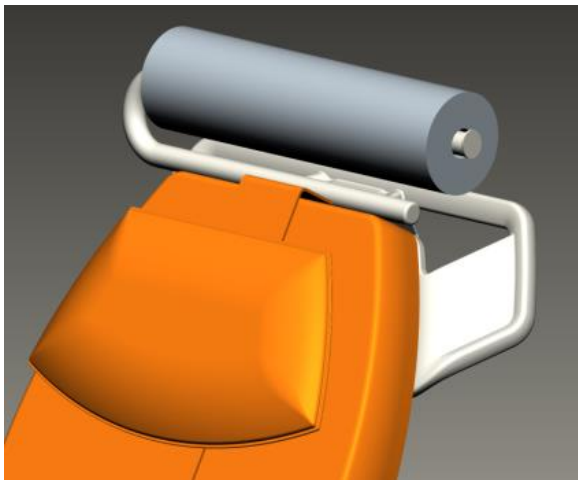

## 10.11 PVC cloth of elbow-rests (a pair)

Place the protective cover on the armrest. (See photo)

Then fasten the velcro straps on the bottom side as shown on the picture below.

Fold the ends of the cover in the order of numbers and arrows.

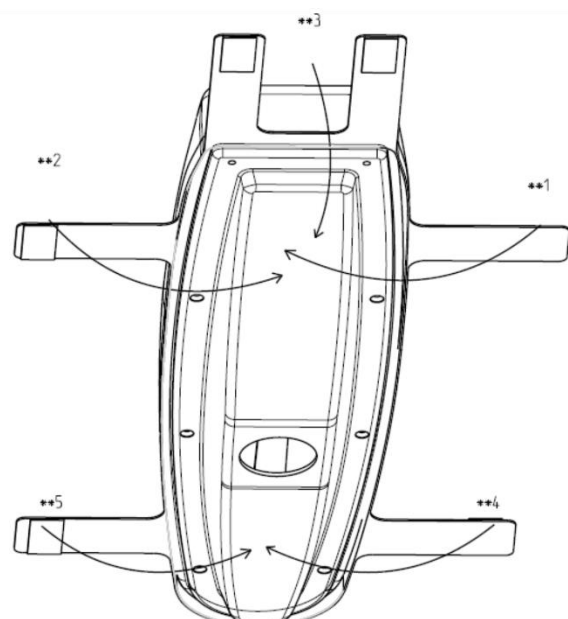

## 10.12 PVC cloth of the leg rest

### Protective cover for foot section:

Place the protective cover on the chair and fasten the ends of the cover (4) by the buttons that are located on bottom side of the padded surface.

Push the buttons through the holes on all four ends of the cover.

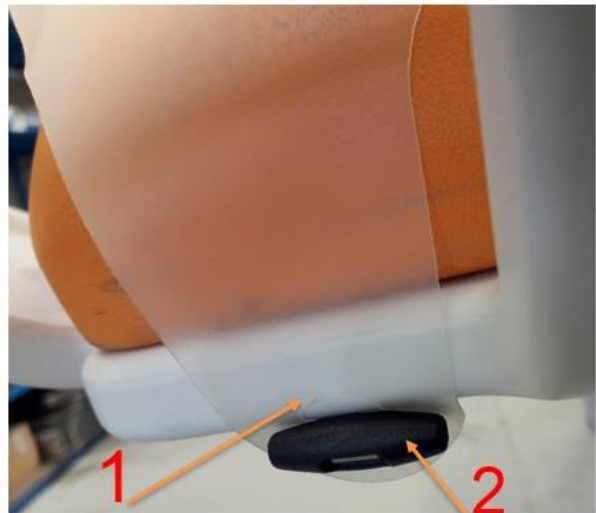
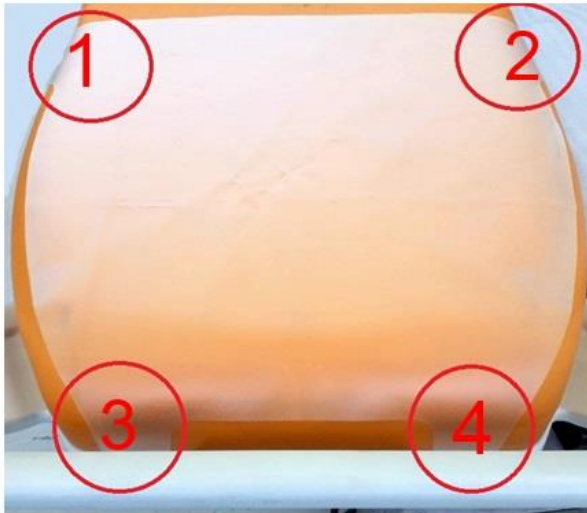

- 1 Push the button through the buttonhole on the cover
- 2 Button

## 10.13 Tablet holder (L/R)



### Warning: Caution

The maximum loading is 0,6 kg!

While using a tablet in the holder, give a special attention to it. A tablet should be always safety laid in the holder to avoid its falling out and damaging.

Parking position of the tablet holder is shown in the picture..

When positioning or moving the chair, the tablet holder must be placed in the parking position to avoid any collision.

The same rules apply to both sides.

The holder is designed for fixing a tablet with dimensions of 7 to 10 inches.

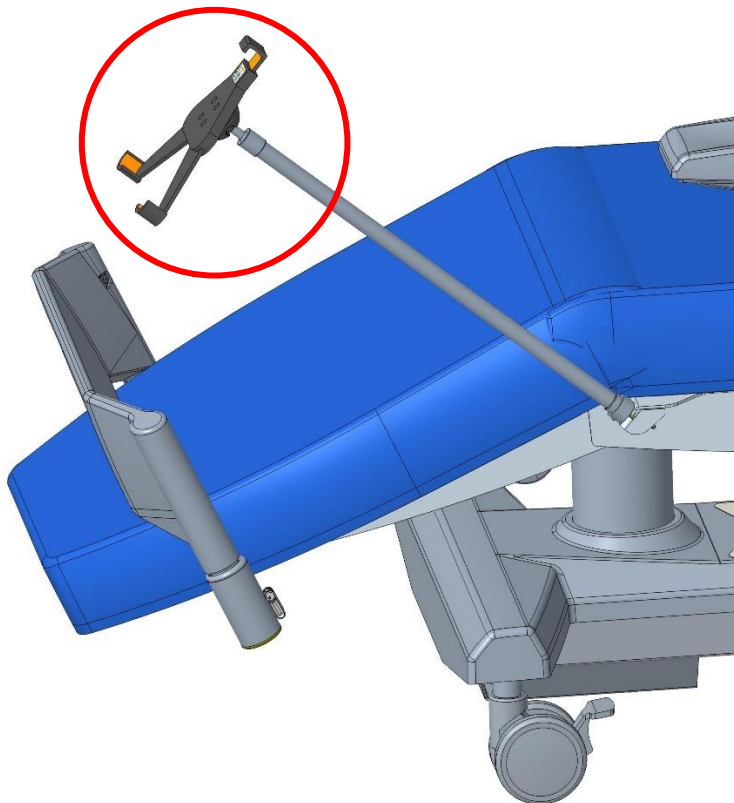



## 10.14 Oxygen bottle holder



**Warning:  
Caution**

The maximum loading is 15 kg!

It is impossible to combine it with the big plastic box!

Please be especially careful during manipulation with an oxygen bottle with the holder. It is always necessary to fix the oxygen bottle with the holder with the help of an attached strap to prevent from its falling out. As far as you don't do so, it can cause an injury of persons or damage of the equipment.

It is designed for fixing the oxygen bottle with the maximum volume of 5 liters.



## 10.15 Urine bag holder



**Warning:  
Caution**

The maximum loading is 4 kg!

It serves for the lodgment of the urine bag (maximally 2 l). It is not possible to combine the lockable box and the holder for an urine bag on the same side of the arm-chair.



## 10.16 Front buffer



**Warning:  
Caution**

The maximum loading is 45 kg!

We recommend it in case of frequent transportation of the chair. Without these accessories, artificial leather can be damaged in case of a collision of the chair with an obstacle!

It serves as a protection of the arm-chair during frequent transportation of the arm-chair with/without a patient. An ergonomic design allows also for a function of a transport handle in the horizontal position of the arm-chair.



## 10.17 Infusion stand

The stand is made of stainless steel. It is possible to perform its telescopic adjustment.



**Warning:  
Caution**

The maximum carrying capacity of one hook is 2 kg!

It serves neither for manipulation with the arm-chair nor as a handle for transportation with the arm-chair.

It is not allowed to use any tray or table attached to the infusion stand. It can cause a cut on the patient, or injure the personal. The upholstery can tear and cause dirt.



## 10.18 Eating table (version with barriers)



### Warning: Caution

The maximum carrying capacity is 15 kg!

During installation of the table or during its extraction, it is always necessary to pay attention on a patient who seats in the arm-chair. It is necessary to avoid a collision with his/her head, body, fingers!

When the table is mounted, it is never allowed to tilt the barriers down.

The table is only allowed to take off when it is empty. In the event that it is not empty, its content can be overturned onto the patient (it could be refreshment, drinks, a notebook, and personal things)!

After having taken off, please save the table in a safe and dry place.

Permitted tilt for mounting the table is 90 °.

### Installation and take-off procedure

While installing the table, firstly mount two fixtures of the table on the left barrier (when viewed from the patient's side seating on the armchair). Slightly pull out the table upward and rotate it to the horizontal plane. The fastener of the table has to clap on the other side; press the right barrier toward you and push this fastener down. The installed table can be (depending on patient's complexion) shifted in the barriers. Demounting of the table is performed in the opposite order.

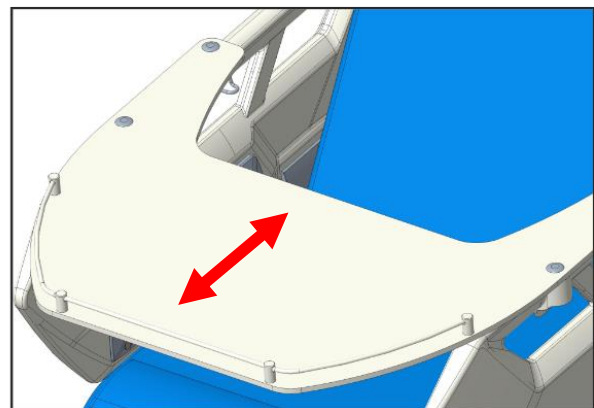
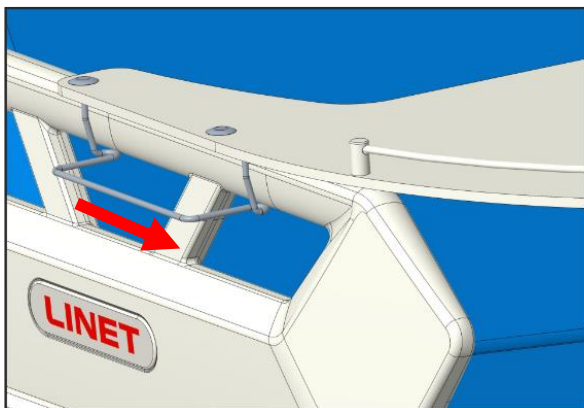
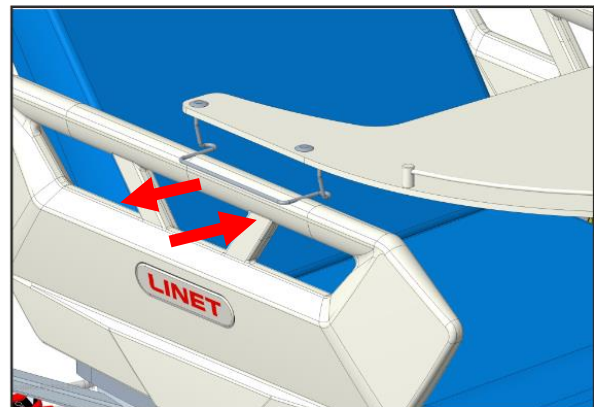
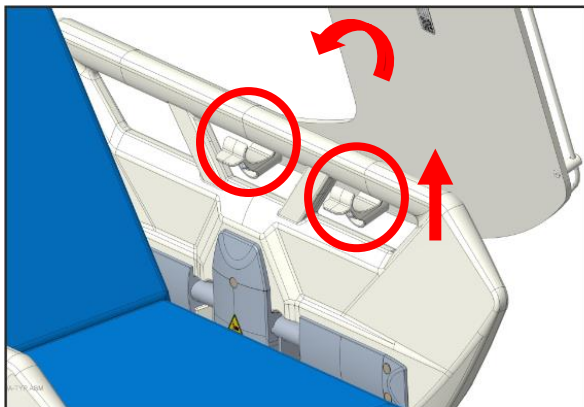

## 10.19 Eating table (for elbow-rest version)



### Warning: Caution

The maximum load capacity is 10 kg!

If a patient is sitting in the chair, take care of the patient while installing or removing the table. Be careful to prevent any collision with the patient!

Never change the elbow-rest position with the table installed.

The table may only be removed if it is empty. If any objects are still on the table (e.g. snacks, drinks, notebooks or personal items), these could fall onto the patient!

Store the table in a safe and dry place after removal.

**The table can be located on the left (SB-ODA -075) or right side (SB-ODA-098) of the chair from the patient's perspective. Tables are not interchangeable!**

### Handling:

### Installation:

Fig. 1 – Table position during installation/removal

Fig. 2 – Installation of pole into holder

1. Grasp the table, insert the table pole into the holder and tighten the screw.
2. Make sure that the table position is rigid.

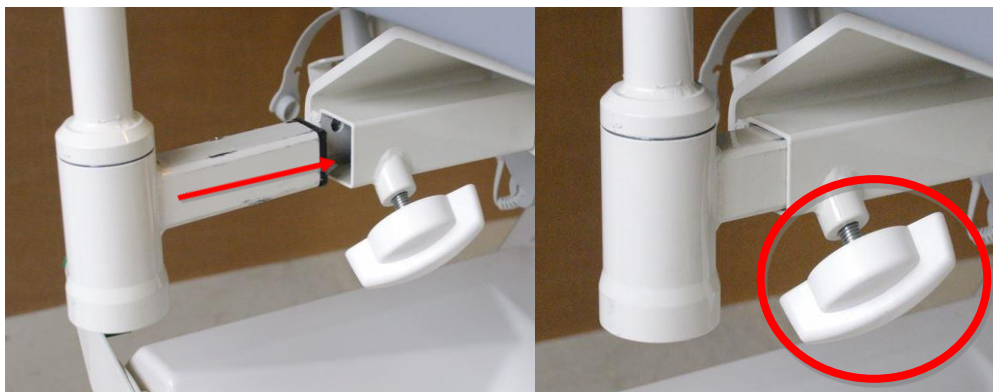

### Eating table movement (rotation)

1. Press the table controller to rotate the table up to 90°.
2. Once the movement is complete, the locking mechanism will click. This means that the table is in the locked position.

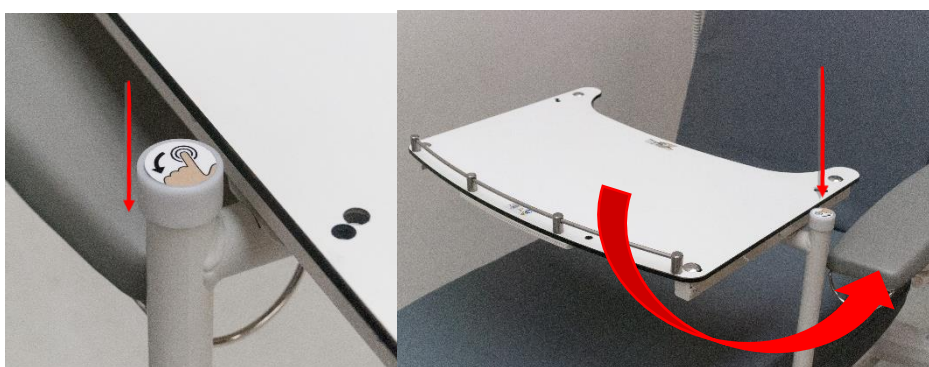

## Eating table movement (back and forward direction)

1. Press the table shift controller to shift the table back and forwards.
2. The maximum shift range is 180 mm

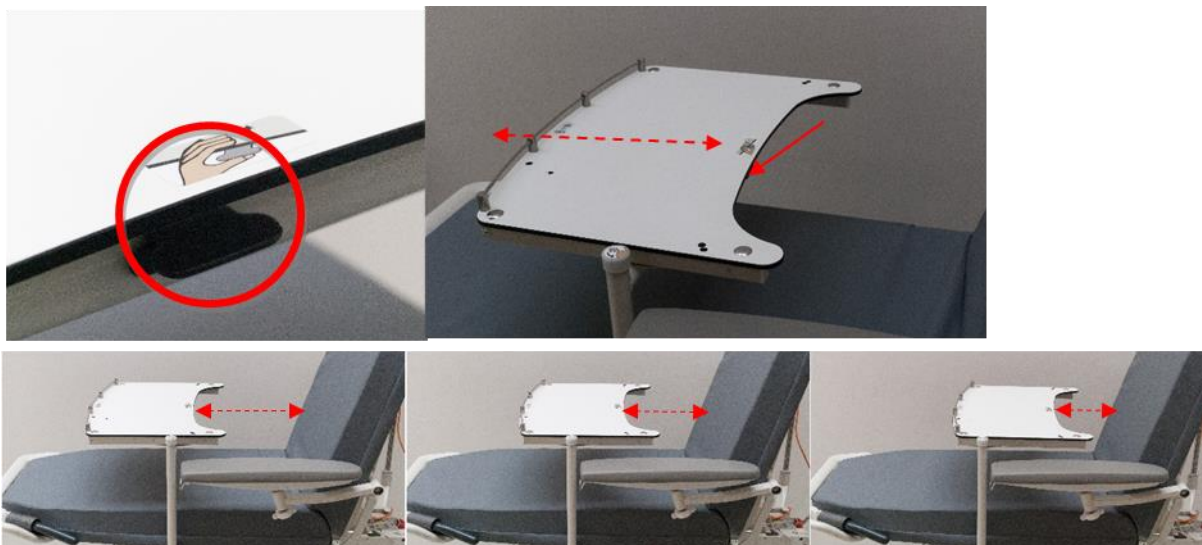

## Removal:

To remove the table, please reverse the installation procedure.

1. Turn the table away from the patient, out of the chair.
2. Hold the table, unscrew the lower screw and pull out the pole.

## Caution:

Take extra care when handling the eating table — risk of collisions with surrounding objects (e.g. elbow-rest).



## 10.20 Front central brake (a pair)

The arm-chair is equipped with a front central brake only for the version with 150 mm wheels for an additional fee. The functions of the wheels are controlled by the brake pedals. Adjustment of the wheel pedal:

<b>STOP</b>	All wheels are blocked
<b>NEUTRAL</b>	All wheels are unblocked and rotate around their axles
<b>GO</b>	Directional guidances with the help of the front or fifth wheel. The remaining wheels are free and rotatable on their axles.

**Meaning of symbols for braking the control pedals:**



## 10.21 Fifth wheel

The arm-chair can be equipped with a fifth wheel placed in the center of the support frame. The fifth wheel allows you to run and navigate the arm-chair in long corridors and small rooms. The version is only with 150 mm wheels.

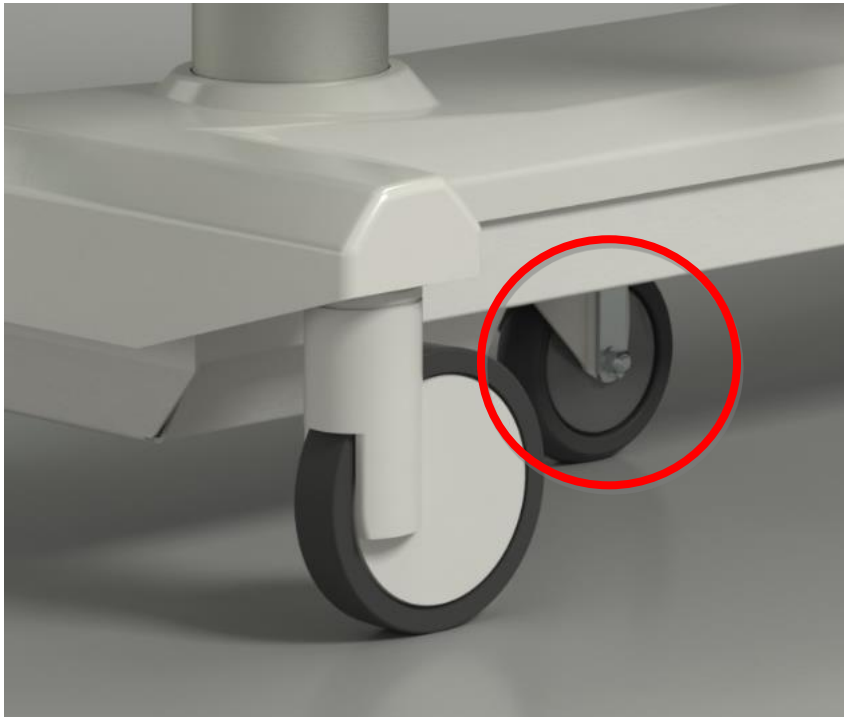

### How to activate the fifth wheel:

1. Disconnect the arm-chair from the main connection.
2. Modify the control of the wheels so that the green lever was directed down (GO).



## 10.22 Electric leg rest



**Warning:  
Caution**

The leg rest doesn't protect the arm-chair against a stroke!  
 The electric leg rest can't be combined with the front buffer!  
 We don't recommend suspension of other accessories on the leg rest!  
 It does not serve as an ascending step!  
 The maximum capacity is 45 kg vertically and 100 kg when squeezed!

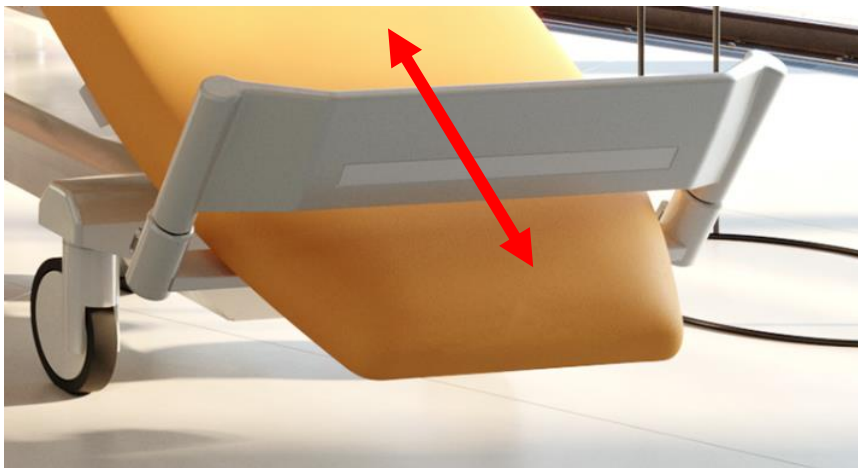

Displacement is possible with the help of the manual controller by holding the push-buttons up and down.

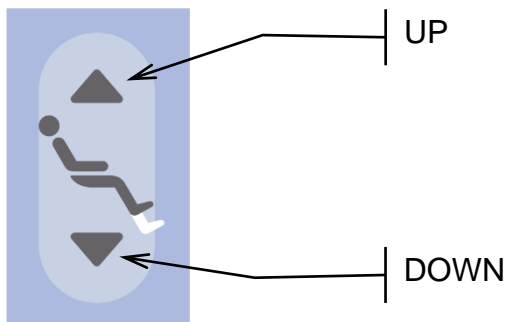



## 10.23 USB cell-phone recharger

The USB charger is used for charging cell phones and tablets

It is situated on the bottom side of the foot section (under the seat) on the right and left side of the chair.

The USB connector has a plastic cover providing an IP protection for the USB connector. When cleaning the chair, this cover must be closed, to prevent water from entering the connector.



**NOTE** Maximum current for this device is 2A.



**Caution:  
Warning:**

### **Risk of injury due to improper use!**

Make sure that the accessories attached to the USB connector are intact

It is the user's responsibility to ensure that this requirement is met.



**Caution:  
Warning:**

### **Risk of injury due to pinched power cord!**

Make sure that the power cord of the attached accessories is not pinched by the siderail or the parts of the backrest section!

It is the user's responsibility to ensure that this requirement is met.



**Caution:  
Warning:**

### **Risk of damage to property due to improper use!**

Make sure that the attached accessories do not fall down!

It is the user's responsibility to ensure that this requirement is met.



**Caution:  
Warning:**

### **Risk of damage to property due to improper use!**

Never connect any heating element to the USB connector!

It is the user's responsibility to ensure that this requirement is met.

## 10.24 Patient fixation band



**Warning:  
Caution**

While positioning the arm-chair, always unbind the patient for his/her safety and comfort. It is especially valid for the movement of the back part and the seat part.

In the case of the use of the fixation band, it is recommended to place the arm-chair in the lowest position.

To ensure higher patient's safety, patients can be fixed on the arm-chair with the leatherette strap in the field of their belly and breast. The accessories is mainly used in a situation when there is a danger of falling down the patient from the arm-chair. The rear holder is designed for the fixation of the leatherette strap.



## 10.25 Front / rear transport handles



**Warning:  
Caution**

The maximum capacity is 45 kg vertically and 100 kg when squeezed!

It serves mainly for easier transportation of the arm-chair with a patient in the horizontal position.

### Front transport handles:

During transport, the handles should be tilted back from the tilted position to the vertical position.

When tilting the handles, the handles must be lifted following the arrows to the 1st position, then tilted to the 2nd position.

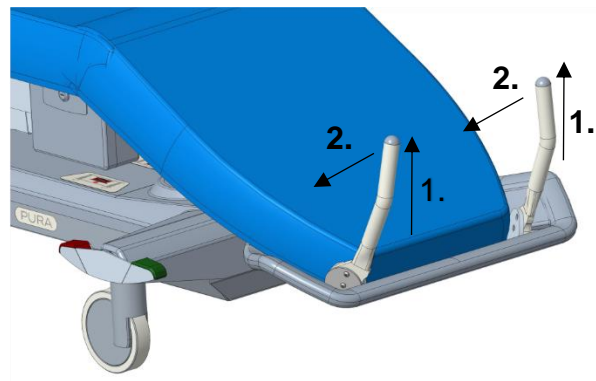
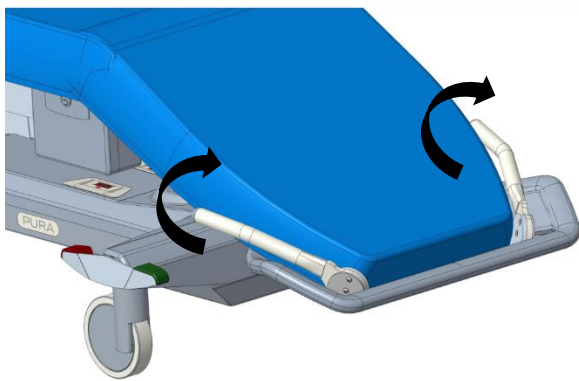

### Rear transport handles:

During transport, the handles should be tilted back from the tilted position to the vertical position.

When tilting the handles, the handles must be lifted in the direction of the arrows to the 1st position, then tilted to the 2nd position.

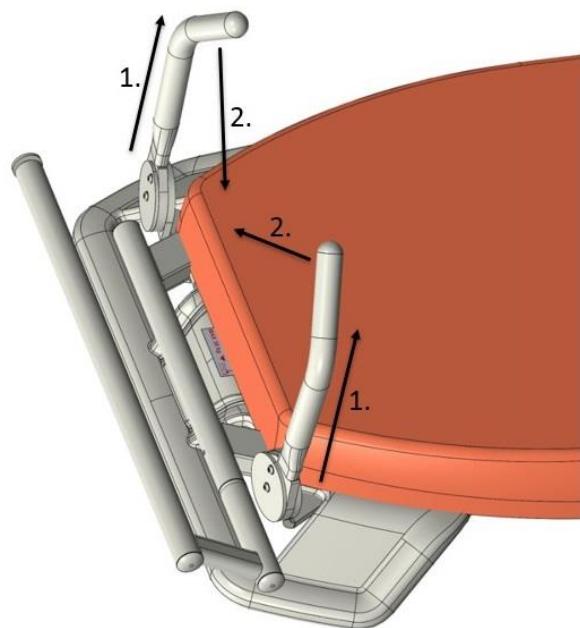
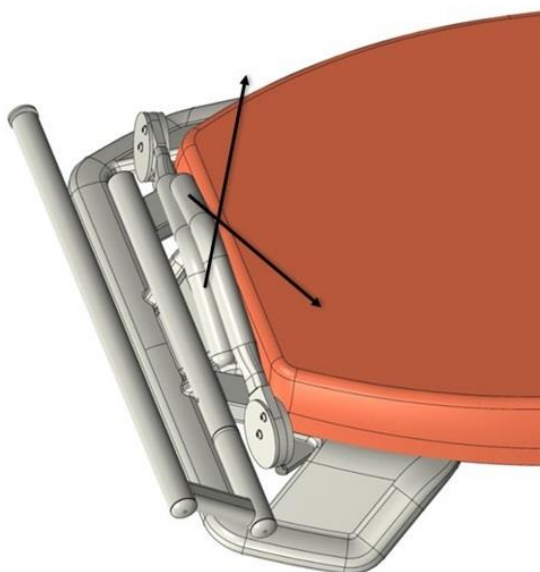

## 10.26 Height-adjustable elbow-rests

Allows to set the height of the armrest at 2 positions, the default position is lower.

**To set a higher position, follow the picture.**

1. Lift the armrest (approx. by 10cm)
2. Slide the armrest lock in

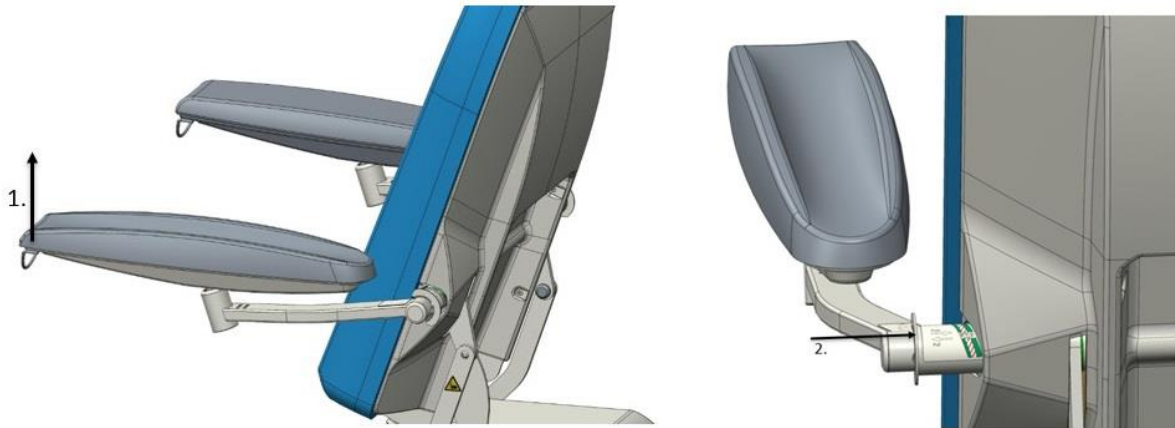

**When returning the armrest to the lower position, follow the picture below:**

1. Lift the armrest
2. Slide the armrest lock out

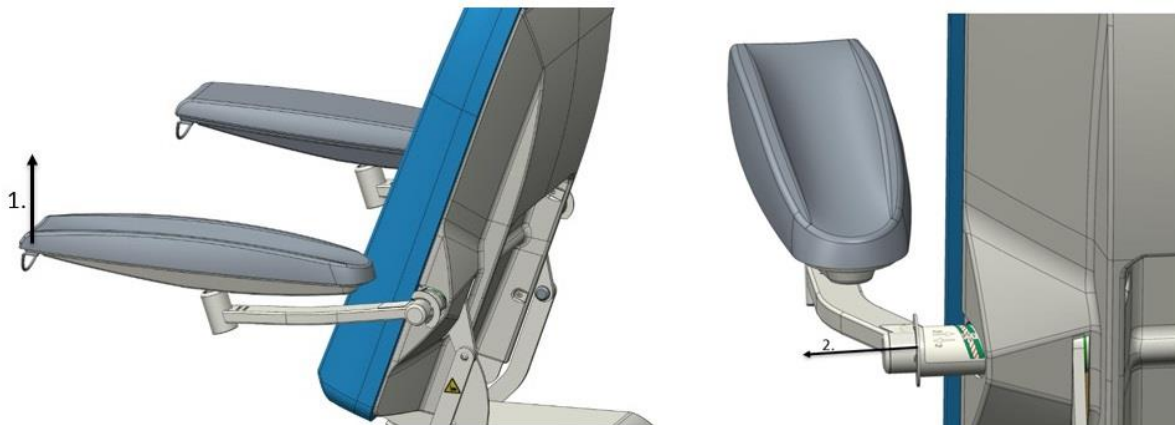

### Explanation of the sticker on the adjustable armrest lock:

- 1 - OK Green – the lock is slid-out correctly (the colour must fit to the edge of the back cover)
- 2 - NOT OK Red – the lock is not slid-in correctly (the lock must not be slid-in in this position)
- 3 - OK Green – the lock is slid-in correctly (the colour must fit to the edge of the back cover)
- 4 - Backrest section cover
- 5 - Schematic representation of armrest manipulation

Position 1 – lift the armrest  
Position 2 – slide the armrest lock in

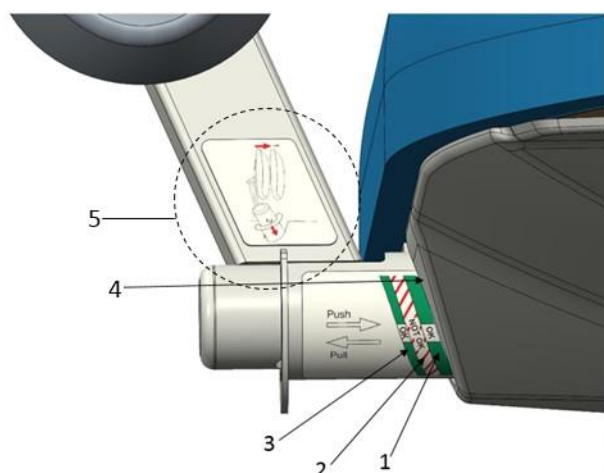

## 10.27 Elbow-rests with cavities for elbows



## 10.28 Controller holder for chair with armrests

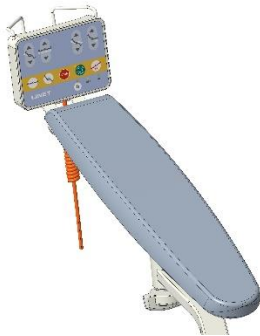

### Controller holder installation

- Insert the controller holder into the hole in the armrest. When the lock engages, the holder is properly inserted

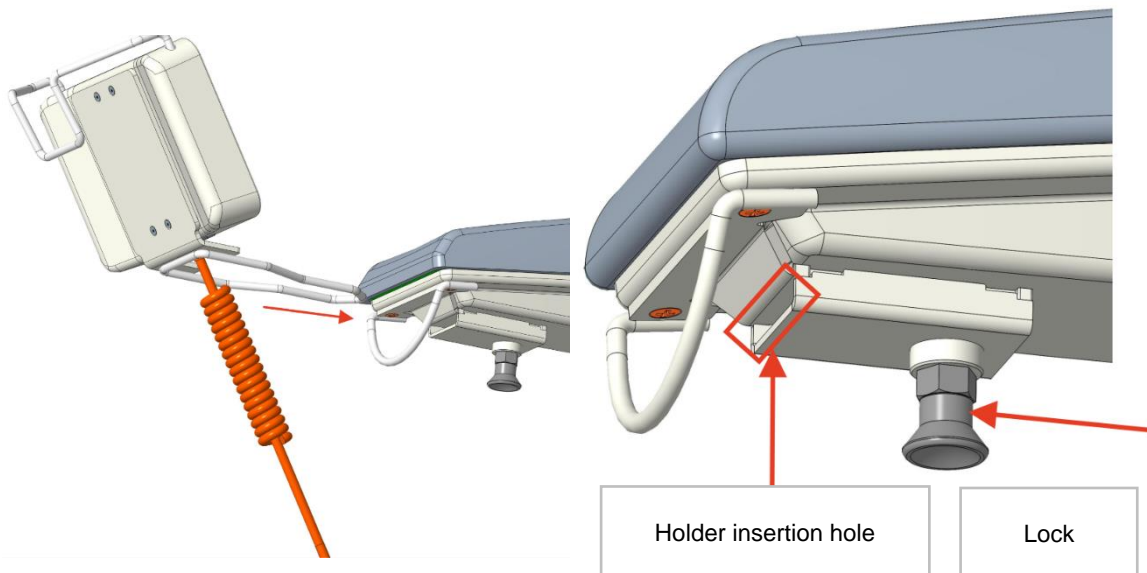

### Removing the controller holder from the armrest

- Slide the holder out while pulling the lock in the direction (1) and sliding the controller in the direction (2) as shown in the picture

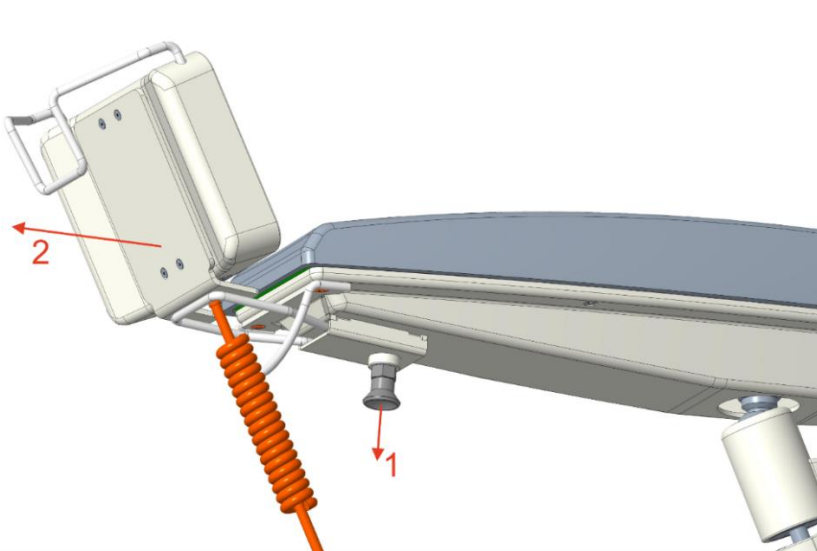

## 10.29 Drink holder for chair with armrests



### Warning: Caution

When using the drink holder, it is important to have the armrest correctly positioned so that the beverage does not tip over on the patient. It is recommended to have the armrest positioned so that the bottom of the beverage is always in a horizontal position.

The holder is intended for use with cold drinks only. There is a risk of burns to the patient if it is handled incorrectly or the holder is hit hard.

### Beverage holder installation

- Insert the drink holder into the hole in the armrest. When the lock engages, the holder is properly inserted.

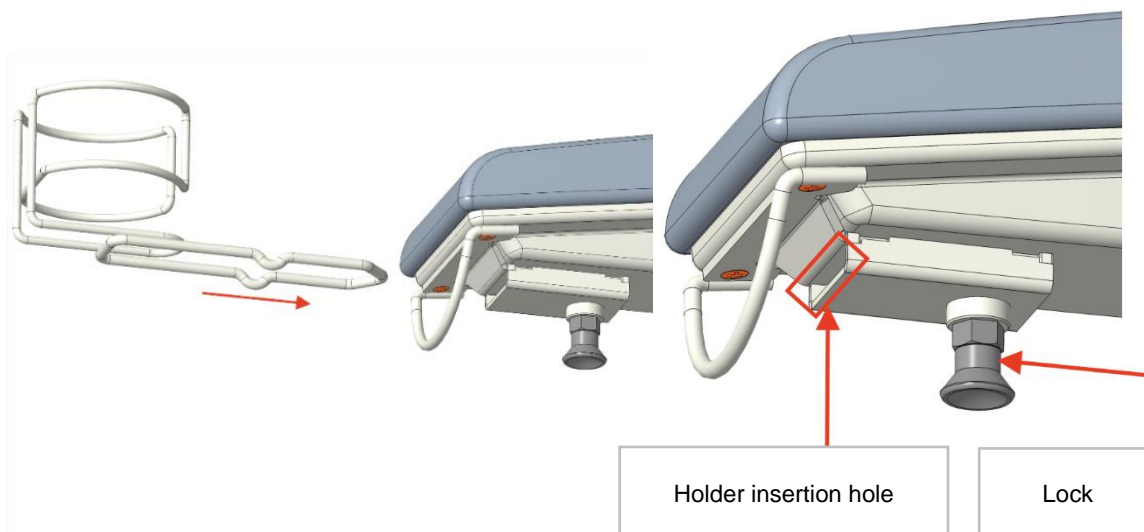

### Removing the drink holder from the armrest

- Slide the holder while pulling the lock in the direction (1) and sliding the holder in the direction (2) as shown in the picture

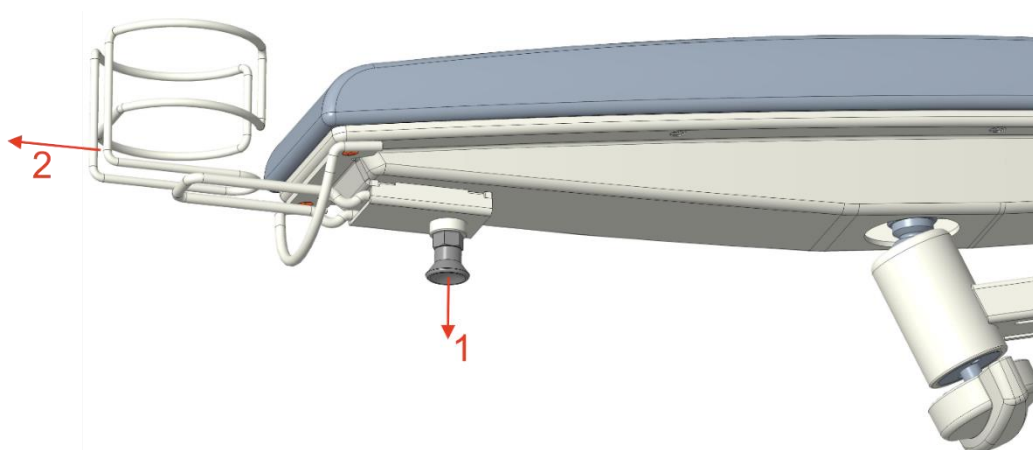

## 10.30 Mechanic CPR



### Warning: Caution

The CPR controller is marked by informative labels on the both sides under the rear section. The labels are marked by a CPR text.

The CPR doesn't serve for individual settings of the back part to different positions, neither for saving time by personnel. To position the back part, always use the function on the manual controller. With the help of the CPR position, it is always necessary to lower up to the lowest, it means straight, position.

The back support has to be loaded during movement (for example, by the patient's weight).

Its movement must be controlled by the personnel. To activate CPR, we recommend you to use one hand and to hold the back section by the second hand.

You can activate the function by pushing the red lever by one hand in the specified direction. Use the second hand to lower the back section with the help of the handle on the rear section. Permanently hold the lever during this movement. To return the back section to the original position, use the motorized positioning (activated by means of the manual control).

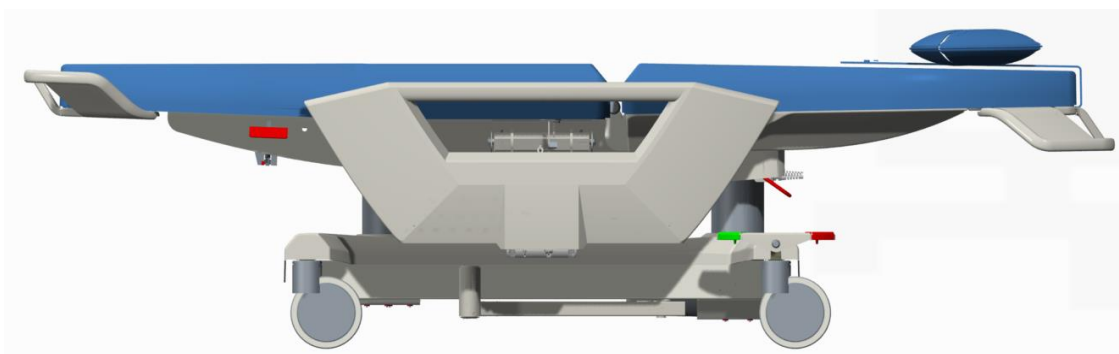



## 10.31 Patient card holder

The patient card holder should be placed on the siderails of the chair and loosely placed on the upper bar of the siderail.

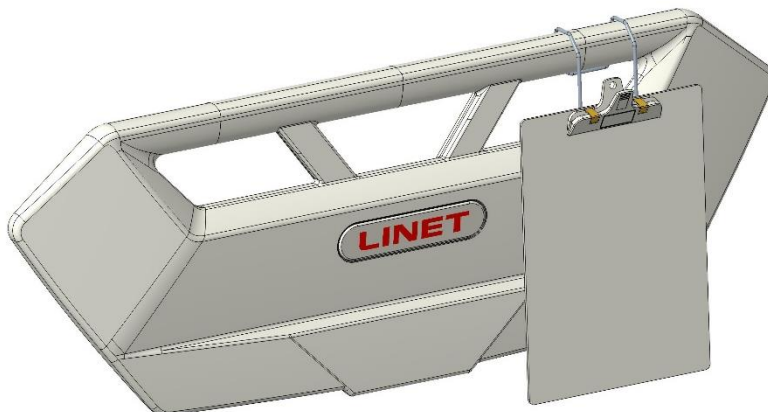

## 10.32 Drinking vessel holder



**Warning:  
Caution**

The holder must always be placed on the upper bar of the siderail. (See photo)  
The holder is for cold drinks only, if the holder is improperly handled or hit hard, the holder may fall on the patient.

It serves for fixing a can or a cup with drink. Before removing the hold, it is always necessary to take out its content. Afterwards rotate the holder by 90° downward and remove it from the barrier. In case of installing, please proceed in the opposite order.

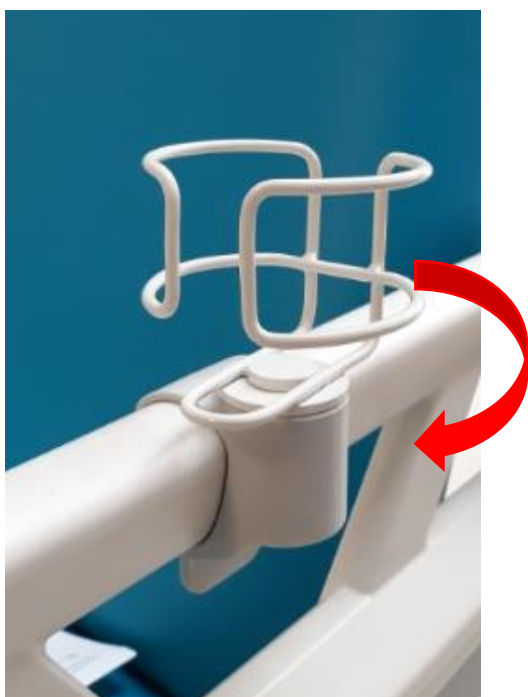

### 10.33 Cell-phone pocket



**Warning:  
Caution**

The pocket should be placed on the siderail on the inside of the chair on the right or left side. (See photo)



## 10.34 Comfort mattress (130 mm)

### Description of the cover

The ODA-COM cover consists of two sections:

1. Removable top section of the mattress cover, fastened by a zip
2. Non-removable lower section of the mattress cover attached to the chair structure

### Technical parameters

Support area	
Total length of the support area	2123 ± 3 mm
Length of the backrest	965 ± 2 mm
Length of the sitting section	528 ± 2 mm
Length of the foot section	630 ± 2 mm
Width of the backrest	590 – 385 ± 10 mm
Width of the sitting section	590 ± 10 mm
Width of the foot section	590 – 388 ± 10 mm
Thickness of the backrest mattress	130 – 100 ± 5 mm
Thickness of the sitting section mattress	130 ± 5 mm
Thickness of the foot section mattress	130 – 80 ± 5 mm

### Recommended manual cleaning and disinfection

To ensure full service life of the mattress, we recommend following these cleaning and disinfection steps.

	<p><b>Step 1.</b> Clean the top and bottom of the mattress with a soft cloth using a solution of water with a universal, neutral detergent.</p>
	<p><b>Step 2.</b> Allow the mattress to dry or wipe dry with a soft cloth.</p> <p><b>Step 3.</b> Disinfect the mattress with a solution containing &lt;math&gt;&lt; 5000\text{ ppm}&lt;/math&gt; of disinfectant recommended in Chapter 9.</p>
	<p><b>Step 4.</b> Rinse with water</p> <p><b>Step 5.</b> Allow the mattress to dry or wipe dry with a soft cloth</p>

### Recommended cleaning in an industrial laundry

Warning:  
Caution.

Do not bleach the mattress cover!  
Follow the recommended settings of the industrial washing machine.  
The cover is not intended for washing in a continuous industrial washing machine.

## Recommended settings of the industrial washing machine



**Warning:  
Caution.**

The cover is not intended for washing in a continuous industrial washing machine

			Washing programme
			9N^h
<b>Washing</b>	Temperature [°C]	a	70 ± 3
	Water level [mm]	b	100
	Wash time [min]	d	15
	Cooling [-]	f	Yes
<b>Rinsing 1</b>	Water level [mm]	b	130
	Rinse time [min]	dg	3
<b>Rinsing 2</b>	Water level [mm]	b	130
	Rinse time [min]	dg	3
	Spin time [min]	d	-
<b>Rinsing 3</b>	Water level [mm]	b	130
	Rinse time [min]	dg	2
	Spin time [min]	d	-
<b>Rinsing 4</b>	Water level [mm]	b	130
	Rinse time [min]	eg	2
		d	5

### Legend

<b>N</b>	Normal movement: 12 s and 3 s idle phase
<b>a</b>	The initial washing temperature refers to the temperature when the heater is switched off
<b>b</b>	The water level is measured from the bottom of the tank after 1 min of the washing machine running and 30 seconds in the idle phase
<b>d</b>	A tolerance of 20 s is allowed for idle phase times
<b>e</b>	No movement is performed during heating until the temperature setting of -5°C is reached. Slight movement is performed from the set temperature of -5°C until the set temperature is reached
<b>f</b>	Cooling: Top up with cold water to the water level of 130 mm and run for another 2 min.
<b>g</b>	The rinse time is measured after reaching the water level
<b>h</b>	Heat to 40 °C, maintain for 15 min during operation before heating to washing temperature

## Procedure for removing the mattress cover

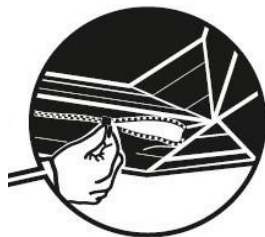

### Step 1.

Set the chair to the flat position.

Feel for the zip — the zip slider is underneath the connecting part of the sitting section and the backrest.



### Step 2.

Loosen the top of the sitting section cover by unzipping it.



### Step 3.

Seat cover partially detached.



### Step 4.

Loosen the top of the backrest cover by unzipping it.

1. Put your hand in the connecting part.
2. Find the zip slider.
3. Carefully unzip the backrest cover zip.

## Procedure for refitting the cover

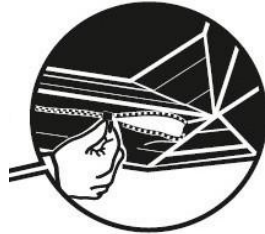

### Step 1.

Set the chair to the flat position. Spread out both the sitting section cover and the backrest cover onto the mattress core.



### Step 2.

Fit the backrest section onto the mattress core







### Step 3.

Lay the sitting section cover over the backrest





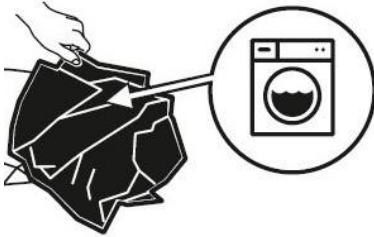



### Step 4.

In the connecting part, insert the zip slider of the backrest cover and fasten along the entire length.

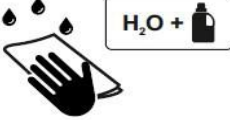
	<p><b>Step 5.</b> Insert the sitting section cover zip in the connecting part and lay the cover over the sitting section core.</p>
	<p><b>Step 6.</b> Put the cover on and fasten along the entire length</p>
	
<p>W</p> 	<p>The removed cover should be washed according to the industrial laundry instructions.</p>

**Symbols on the mattress**

	<p>HAND WASH, HAND MAINTENANCE</p>
	<p>WASH IN AN INDUSTRIAL WASHING MACHINE</p>
	<p>DISINFECT WITH A SOLUTION CONTAINING &lt;math&gt;&lt; 5000\text{ PPM}&lt;/math&gt;</p>
	<p>RINSE WITH WATER</p>
	<p>WIPE WITH A SOFT CLOTH AND A SOLUTION CONTAINING A GENERAL PURPOSE DETERGENT</p>
	<p>BATCH NUMBER</p>
	<p>RECYCLING SYMBOLS</p>
	<p>The upholstery conforms to BS 7177 fire resistance requirements in the medium hazard category.</p> <p>The upholstery conforms to the requirements of standards BS EN 1021-1, BS EN 1021-2, BS 5852 — resistance to ignition source 5</p>



## 10.35 Backup battery



### Warning: Caution

Only service personnel is entitled to replace the battery!

The battery replacement by insufficiently trained personnel is dangerous and can reduce functionality of the medical device!

The battery is charged automatically from the control unit and requires no special maintenance.

If there is a difference between the temperature of the chair and the ambient temperature (transportation/storage) in the place where you intend to install the chair, it is necessary to wait 24 hours until the chair temperature was stabilized to the room temperature. Then connect the power.

Use the battery only in crisis situations (for example, power outage, transport of a patient, etc.).

On the next connection of the chair to the power, charge the battery to its full capacity.

A defect battery can generate gas. Occasionally it can cause deformation of the battery box and the control unit. If it happens, the chair must be immediately put out of service and store in a well-ventilated room without sparking (neither electrics nor fire)! Inform immediately the service department of the producer!

**To achieve declared service life of the lead batteries, it is recommended that the following actions be taken during storage:**

1. Exclude their deep discharge (state of charge under 70%) and maintain them at least partly charged by means of regular charging.
2. Store them in a dry and cold place (from 10°C to 0°C).
3. Do not expose them to direct sunlight.

**The battery supplied with the chair is not charged. The battery only serves as a backup power supply in case of power outage or for patient transportation.**

- The chair must be only equipped with batteries approved by the manufacturer.
- The manufacturer gives 6-month warranty for the full functionality of the battery.
- These batteries maintain smooth functioning only for a certain period of time, which is given by general physical and chemical laws and by the method of application. The user has an obligation to monitor the state of charge of the accumulators and recharge them according to the service instructions. It is necessary to check the batteries by away specified in the service instructions at least once a month.
- The manufacturer recommends that the batteries should be replaced by a service organization after 2 (two) years. The assumed service life of the battery ends at the end of this period, and the manufacturer is not able to guarantee service life of the battery.
- After 5 (five) years, however, it is necessary to replace the battery by a new one approved or recommended by the manufacturer.
- The manufacturer has no responsibility for damage of the chair or the battery caused by: a failure to comply with the manufacturer's manual or the service instructions; the use of other battery for the chair; replacement of the battery by an unqualified service organization.

**The battery is evaluated as defective in case that one of the following conditions is valid:**

- permanent charge of the battery (longer than 12 hours)
- low battery voltage
- low battery charging current

**The state of "fault battery" is:**

- indicated by permanent lighting the battery indicator

**The battery is evaluated as discharged under the following condition:**

- defined voltage decline depending on the discharging current

**The state of "discharged battery" is:**

- indicated by quick flashing the battery indicator

## Indication of the battery status

Yellow LED diode	Battery status
No light	Battery capacity is sufficient (the battery is fully charged before the start of the use)
Short flashes (short flash, longer period without lighting) (1.8 sec. about)	Battery charging - continue charging until the indicator lamp goes out. In emergency cases, it is possible to use the battery as a backup power supply. If the indicator lamp continues flashing after 12 hours or terminates flashing but it is impossible to position the chair, it means that the battery is defective (please, contact the manufacturer).
Long flashes (long light, short period without lighting) (0.2 sec. about)	Low battery voltage - it isn't allowed to use it as a backup power supply, even for a short term; the battery is fully discharged or defective (in the case of long-term signalization of this type, it is necessary to replace the battery - it is a service operation).
It lights continually within a few hours (about 10 hours), in spite of the chair is connected to the mains	The absence or the failure state of the battery (the batter is incorrectly connected, there is an interrupted connection between the power supply and the battery), or there are defective fuses of the battery), in case of this signalization, please contact manufacturer service.

## Battery Activation if ordered as option



### Warning: Dangerous voltage

With regard to the possibility of unwanted switching on of PURA upon packaging, transport and unpacking, the battery is normally disconnected from the equipment.

If isolating foil is damaged, contact the manufacturer's service department immediately.

The following pictures show how to connect the battery. Only service technician approved by manufacturer performs this procedure. To remove isolating foil:

1. Remove isolating foil from mains control box by pulling strap.



2. Check if isolating foil is complete and undamaged as shown in figure Detail of Isolating Foil.

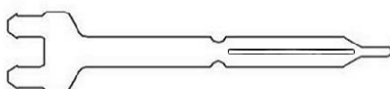

## 11 Care

All LINET spol. s r.o. products are designed for many years of service under the conditions of correct use. Please use your chair and its accessories carefully. Please follow these instructions and the herein described chair operation procedures. Avoid negligent handling. Do not, in case of a function failure, undertake any repairs and never use force!

### 11.1 Cleaning and disinfection



#### Warning: Caution

Do not use any automated cleaning or disinfection methods!

For basic cleaning use a soft cloth and only a pH-neutral solution of a multi-purpose cleaning detergent.

For disinfection, we recommend using standard surface disinfectants, e.g. based on quaternary ammonia compounds, peroxy compounds. The dilution ratio recommended by the Manufacturer of a specific disinfectant must be followed at all times!

Do not use any abrasive washing aids or ketone-based solvents (such as Nitro, Acetone, etc.).

By using too much water you risk water leakage into the motor parts of the product, which may damage the electric wiring and render the product not functional.

In case of improperly performed cleaning and disinfection, there is a risk of nosocomial infection.

Put the upholstery on dry chair areas only.

When cleaning, place the footrest upholstery on the flat side.

This medical device with all its parts and accessories is not designed to undergo sterilization.

LINET spol. s r.o. is not responsible for damage to the cushioning (e.g. cracking, paint flaking etc.), which would result from improper use of disinfectants. In such cases, warranty claim shall not apply.

Discoloration of the upholstery due to the transfer of color pigment from clothing or other products coming into contact with the surface (e.g. jeans pants) is not a sign of reduced quality of the leatherette and this discoloration cannot be claimed under warranty.



#### Warning: Caution

#### Risk of property damage caused by improper cleaning/disinfection!

Check if used cleaning agents and disinfectants are compatible with materials that the product consists of! For information see the following table:

Components of the chair	Materials used
Undercarriage construction, frame construction, drink holder, paper roll holder	Painted steel
Upholstery seat, backrest, headrest, headrest extension, wedge cushion, patient belt, mobile phone pocket, protective film	Polyvinylchloride (PVC)
Castors	Polyurethane foam (PUR), polypropylene (PP)
Siderail, front handle, rear handle	Polypropylene (PP)
Armrests	Painted steel, acrylonitrile butadiene styrene (ABS), polyvinylchloride (PVC)

Components of the chair	Materials used
Undercarriage cover, seat cover, backrest cover, tablet holder	Acrylonitrile butadiene styrene (ABS)
Columns	Anodized aluminium alloy
Storage box	Acrylonitrile butadiene styrene (ABS), painted steel
Labels	Polyethylene terephthalate (PET)
Drives	Polyamide 6 (PA6), aluminium (Al)
Foldable back handles, foldable leg handles, lamp, armrest table	Painted steel, acrylonitrile styrene acrylate (PVC)
Footrest	Painted steel, polypropylene (PP)
Handset	stainless steel, acrylonitrile butadiene styrene (ABS), polyethylene (PE)

In terms of the hygienic preparation process, that the corresponding dialysis centers or day surgery center room and all the furnishings and medical devices used, must be cleaned or disinfected directly and promptly after an occupancy in order to prepare the premises for a new occupancy. This means that such cleaning affects all parts of the chair. Due to a rapid change of patients in one place, there is an increased demand on the best possible balance between necessary and possible cleaning procedures. The procedure must be examined and reconciled with and / or supplemented in the hospital guidelines, recommendations for hygiene plans and implemented measures. After patients with a known infection, special cleansing and disinfecting measures must be used. Such procedures are subject to hospital directives as described above and must be clarified accordingly. For infection control, it is recommended to use prefabricated, protective covering drapes and / or covering fabrics which additionally cover the hygienically sensitive components of a chair - seat, back, and foot section to avoid the skin contact of the patient with the upholstery.

### 11.1.1 Cleaning the chair

1. Supporting area including the head pillow starting from the head section toward the lower section;
2. Hangers and hand grips;
3. Siderails/armrests;
4. Frame of the chair;
5. Lift the left chassis plastic cover and clean dirty areas.
6. Infusion stand and holder;
7. Casters and brake pedals.

## 11.1.2 Recommended disinfection (disinfectants for wiping)

RTU- Ready-to-use non-diluted products – spray or foam		
Active substance	How to use	Example of disinfectant
Amine, Alcohol up to 30%	Spray and wipe	Incidin foam
Hydrogen Peroxide	Spray and wipe	Incidin OxyFoam S
Alcohol till 30%	Spray and wipe	Bacillol 30 Foam
Disinfection wipes		
QAS	Wipe	Sani cloth active
Hydrogen Peroxide	Wipe	Incidin OxyWipe S
Amine, Alcohol up to 30%	Wipe	Bacillol 30 tissues
Concentrated disinfectants, to be diluted		
Active substance	Concentration of the prepared solution of the disinfectant	Example of disinfectant
Glukoprotamine	0,5%	Incidin plus
Amine, QAS	0,5-1%	Terralin protect
Oxygen, QAS	1%	Desam OX
Oxygen, QAS	1%	Incidin Oxydes
Amine, QAS	0,5%	Incidin pro
Amine, QAS	0,5%	Surfanios premium
Oxygen	0,5%	Anios Oxy Floor
Oxygen	1%	Incidin Active
Oxygen	1%	Perform

**Warning! Do not use disinfectants with active substance: alcohol over 30%, active chlorine, iodine, aldehydes**

## 12 Maintenance

Treads of fastening screws or the joints on the frame parts may get degreased by disinfectants. In these cases, timely lubrication prevents costly repairs.



**Warning:  
Dangerous electric voltage**

Within the scope of annual regular revisions of a medical equipment, it is necessary to check the battery voltage (loadless). If the measured value is below 12V (24V in case of measuring two battery cells together), it is necessary to replace the battery immediately.

## 12.1 List of error, malfunction and generated messages

Problem description	Likely cause	Action to be taken by the operator to solve the problem	Actions to be taken by the qualified service personnel
The chair does not react to commands.	Probably the chair is not plugged in and the battery is already fully discharged.	Connect the power cable to the mains and also to completely recharge the battery if fully discharged.	Verify that the mains are under current and that the socket is working. Use another socket.
The hand controller or one of the buttons of the hand controller does not react.	The cable connecting the hand controller with the chair is not properly plugged into the connector of the chair.	Make sure visually the cable connecting the hand controller is plugged into the chair.	Verify whether the chair works with another hand controller. If so, replace it.
One of the engines fails to react.	The cable that connects the engine with the chair is not inserted into the connector of the Chair.	Make sure visually the cable connecting the engine is plugged in to the chair.	Verify that the chair works with another engine. If so, replace it.
After back up battery is fully charged the chair is still not working on the battery	Life time of the battery is over	<p>Make sure visually the cable connecting the hand controller is plugged into the chair</p> <p>Make sure visually the cable connecting the engine is plugged in to the chair.</p>	<p>Within the scope of annual regular revisions of a medical equipment, it is necessary to check the battery voltage (loadless). If the measured value is below 12V (24V in case of measuring two battery cells together), it is necessary to replace the battery immediately</p> <p>Verify whether the chair works with another hand controller. If so, replace it.</p> <p>Verify that the chair works with another engine. If so, replace it.</p>
The chair cannot be set with the help of position push-buttons	The GO push-button wasn't pressed	Press the GO push-button	Contact service
The chair cannot be set with the help of position push-buttons	The Lock push-button wasn't pressed	Press the Lock push-button	Contact service

## 12.2 Technical parameters

<b>Rest area</b>	
Total rest area length	2123 ± 3 mm
Back section length	965 ± 2 mm
Seat section length	528 ± 2 mm
Foot section length	630 ± 2 mm
Back section width	590 – 385 ± 10mm
Seat section width	590 ± 10mm
Foot section width	590 - 388 ± 10mm
Back section mattress thickness	90 – 58 ± 5mm
Seat section mattress thickness	100 ± 5mm
Foot section mattress thickness	100 – 75 ± 5mm
<b>Dimensions</b>	
Minimum height – castors 100mm	554 ± 3mm
Maximum height – castors 100mm	934 ± 3mm
Minimum height – castors 150mm	590 ± 3mm
Maximum height – castors 150mm	970 ± 3mm
Vertical lift	380 ± 3mm
Maximum height of the chair – sitting (lower) position – castors 100mm	1417 ± 5mm
Maximum height of the chair – sitting (lower) position – castors 150mm	1454 ± 5mm
Maximum length of the chair – lying position – back section with handle + foot section empty	2203 ± 5 mm
Maximum length of the chair – lying position – back section with handle + foot section with handle / foot support	2278 ± 5 mm
Maximum length of the chair – sitting position	1715 ± 5 mm
Chair width – side supports in upper position	740 ± 5 mm
Chair width – side supports in lower position	778 ± 5 mm
Chair width – armrests in basic position	892 ± 5 mm

<b>Castors</b>	
Castor diameter / brake	150 mm / central, total
Castor diameter / brake	100 mm / without central, total
<b>Adjustment angles:</b>	
Back section adjustment angle	$0^{\circ} \pm 1^{\circ} / +70^{\circ} \pm 2^{\circ}$
Seat section adjustment angle	$0^{\circ} \pm 1^{\circ} / -12^{\circ} \pm 1^{\circ}$
Foot section adjustment angle	$0^{\circ} \pm 1^{\circ} / +33^{\circ} \pm 2^{\circ}$
Trendelenburg position	$-12^{\circ} \pm 1^{\circ}$
CPR position	$0^{\circ} \pm 1^{\circ}$
Armrest adjustment angle - vertical	$+42^{\circ} \pm 3^{\circ} / -8.5 \pm 3^{\circ}$
Armrest adjustment angle - horizontal	360°
Swinging upwards – measured in the sitting position	swinging by 122°
<b>Permissible load</b>	
SWL (safe working load)	205 kg
Patient weight	190 kg
Product weight (with siderails)	113 kg
Product weight (with armrests)	104,5 kg
Back section permissible load (125 mm from the edge)	30 kg
Foot section permissible load (125 mm from the edge)	45 kg
Side rail permissible load – vertical force	70 kg
Side rail permissible load – lateral and horizontal force	50 kg
Armrest permissible load – vertical force at the end of the armrest	30 kg
Permissible load of the infusion stand holder - vertical	8 kg (2 kg each hook)
Permissible load of the infusion stand holder – horizontally, 1m above the holder	10 kg



## 12.3 Electrical parameters

Batteries – back-up	24V/1,2 Ah
Voltage – input	100 V AC, 315 VA
Voltage – input	110 V AC, 350 VA
Voltage – input	120 V AC, 380 VA
Voltage – input	127 V AC, 400 VA
Voltage – input	230 V AC, 370 VA
Frequency	50/60 Hz
Motor voltage	24 V
Ingress protection of the multifunctional chair	IPX4
Device protection class	I.
Classification of applied parts	B, BF
Chair fuses	2xT1, 6 AL 250V, (version 230V), 2x T3, 15 AL 250V(version 100-127V)
Battery	Pb AKU 2 x 12 V / 1,2 Ah / Fuse 15A

## 12.4 Storage instruction and transport

During storage and transport, no heavy objects should be placed on the chair. Putting extra object on chair during storage is not allowed. Chair must not come into direct contact with flames or other flammable materials.

Packed chair can be exposed for a period of 15 weeks to weather conditions with the following limit values

- Operation: 10°C – 40°C, 30% – 75%, 795 hPa – 1060 hPa
- Storage and Transport: -10°C – 50°C, 20% – 90% (non-condensing), 795 hPa – 1060 hPa

## 12.5 Service and repairs



### Warning: Caution

All service revisions, safety and technical inspections or service interventions must be executed only by a technician trained by L I N E T spol. s r.o. company.

Diagrams, lists of product parts, descriptions or other information intended to help the service personnel with the repair of product parts, repairable by the service personnel only as implied by the manufacturer, are available upon demand at the manufacturer.

The product is provided with the warranty period of 2 years on conditions that regular annual service inspections are carried out.

For all medical equipment produced by the L I N E T spol. s r.o. company, the operator must ensure regular technical safety inspections according to the producer's recommendation, thus the inspections must take place at least 1x per year or after the carrying out of any repair of the medical equipment or after any intervention regarding the electrical system of the medical equipment. The details about the scope, parameters and procedures of the technical safety inspection are specified in the service manual of the medical equipment.

### The extended warranty does not cover:

- batteries (these are provided with the warranty of 6 months)

From practical testing results, the technical lifespan of the product is 15 years; lifespan of the battery is limited and must be replaced; gas springs need to be replaced every 12 years.

In case the product is not functioning, please contact the product dealer in your country. In case of any other problems, please contact (preferably in English) the manufacturer at:

For repairs, please use only the original L I N E T spol. s r.o. spare parts and the services of trained service technicians licensed to repair products of this type. Unprofessional repairs shall be considered as a substantial breach of the warranty terms and conditions and the manufacturer simultaneously does not bear any responsibility for any further possible damage to the product which might result from unprofessional intervention.

## 12.6 Applied parts

The applied parts of the product are of type B - providing a moderate degree of patient protection.

- padding / mattress
- armrests
- siderails

The applied parts of the product are of the BF type - providing a moderately high degree of patient protection.

- hand control

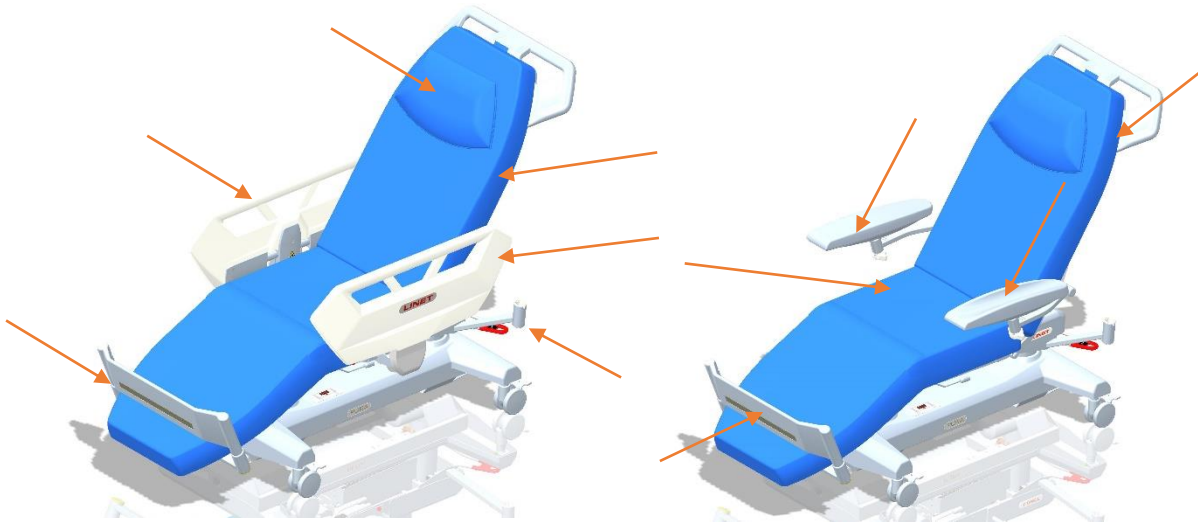

## 13 Disposal

### 13.1 Environment protection

The LINET® company is aware of the importance of environmental protection for future generations. Within this company the environmental management system is applied in accordance with the internationally agreed standard ISO 14001.

The compliance with this standard is annually tested by the external audit executed by an authorised company. Based on the WEEE - Waste, Electric and Electronic Equipments Directive the company LINET, s. r. o. is registered in the List of Electric and Electronic Equipment Producers (Seznam výrobců elektrozařízení) on the Ministry of the Environment of the Czech Republic (Ministerstvo životního prostředí).

Materials used in this product and in the LINET® accessories are not environmentally hazardous. The LINET® products and the LINET® accessories meet valid requirements of national and European legislation in the areas of **RoHS** and **REACH**, so they do not contain any prohibited substances in excess quantities.

None of the wooden parts is made of tropical wood (such as mahogany, rosewood, ebony, teak etc.) or made of timber from the Amazon region or from similar rainforests. Product noise (sound pressure level) meets requirements of the regulations for the protection of public health against undesirable effects of noise and vibration in protected interior spaces of buildings. Used packaging materials are in accordance with requirements of the Packaging Act (**Zákon o obalech**).

For disposal of packaging materials after installation of products contact your sales representative or manufacturer's customer service about the possibility of a free take-back of packaging through an authorized company (more details on [www.linnet.cz](http://www.linnet.cz)).

### 13.2 Disposal

Materials used in this product and in the LINET® accessories burden the environment but at the same time the whole range of these materials can be very effectively reused and recycled. Mechanical disassembly of the product and material sorting into the basic waste types (plastic, metal, wooden materials) should be performed after the end of product life. The main objective of the obligations arising from the European Directive on Waste, Electric and Electronic Equipments is to increase the re-use, material recovery and recovery of electric and electronic equipment at the required level, thereby avoiding the production of waste and thereby avoiding the possible harmful effects of hazardous substances contained in electric and electronic equipment on human health and the environment.

LINET® electric and electronic equipment that have a built-in battery or accumulator and LINET® accessories are designed so that the used batteries or accumulators can be safely removed by LINET® qualified service technicians. There is an information about its type on the built-in battery or accumulator.

#### 13.2.1 Within Europe

##### **To dispose of the electric and electronic equipment including LINET® accessories:**

- The electric and electronic equipment must not be disposed of as household waste.
- Dispose of this equipment at designated collection points or take-back points.
- Dispose of the product or its components or its accessories in accordance with local laws and regulations!
- Hire an approved waste disposal company for disposal!

##### **To dispose of the other equipment including LINET® accessories:**

- The equipment must not be disposed of as household waste.
- Dispose of this equipment at designated collection points or take-back points.

LINET® participates in a collective system with take-back company REMA System (see [www.remasystem.cz/sberna-mista/](http://www.remasystem.cz/sberna-mista/)).

By bringing electric and electronic equipment to a take-back point, you participate in recycling and you save primary raw material resources while protecting your environment from effects of unprofessional disposal.

## 13.2.2 Outside Europe

- Dispose of the product or its components or its accessories in accordance with local laws and regulations!
- Hire an approved waste disposal company for disposal!

## **14 Warranty**

L I N E T spol. s r.o. will only be held responsible for the safety and reliability of products that are regularly serviced and used in accordance with the safety guidelines.

### **Should a serious defect arise that cannot be repaired during maintenance:**

- ❖ Do not continue to use the chair.

The warranty on this product and its conditions are dependent on the agreement between the buyer and the seller. The warranty covers all material and manufacturing-related failures and errors. Failures and errors caused by incorrect use and external effects are not covered. Justified complaints will be fixed free of charge during the warranty period. Proof of purchase, with the date of purchase, is required for all warranty service. Our standard terms and conditions apply.